



ELBRUS

SPRING / SUMMER
2023
CATALOG





GLOVE CLICK A glove-integrated strap for quick click in and out of the Nordic Walking pole to put the pole down without removing the gloves.

OUTDOOR ACCESSORIES

TRAVEL



MEMORY FOAM The memory foam applied in the pillow adapts perfectly to the shape of the head and neck, providing comfort and support.



REMOVABLE COVER Removable cover facilitates keeping the pillows clean.

SPORT ACCESSORIES

THERMOS / WATER BOOTLE ETC.



VACUUM INSULATION Vacuum insulation applied in Thermoses or thermal cups ensures long lasting heat of the liquid, using low thermal conductivity of the vacuum between the vessel walls.



STAINLESS STEEL Stainless steel of which the inner walls of the thermos or thermal cup are made is resistant to high temperatures and corrosion.



QUICK STOPPER The quick opening and closing system is practical in any conditions.



ANTI-LEAK Locking system that prevents fluid leakage.



BPA FREE Product doesn't contain Bisphenol-A.



FOLDABLE Foldable product - practical and easy to transport.



3 IN 1 Three functions in one product



LIGHTING

LUMENS The amount of light produced by the flashlight.



ON/OFF SENSOR Motion sensor to turn on/off the light with a simple wave of your hand in front of the light.



WHITE LEDs LED lamp emitting white light. LEDs are resistant to shock and impacts. They are characterised by durability and longer working time.



RED LEDs LED lamp emitting red light. LEDs are resistant to shock and impacts. They are characterised by durability and longer working time.



3 LIGHT FUNCTION Three lighting modes.



5 LIGHT FUNCTION Five lighting modes.



WATERPROOF IPX4 IPX4 offers protection from a splash of water in any direction for at least 5 minutes and protects from entering the casing objects above 1mm.



LI-ION BATTERY Type of rechargeable battery.



USB RECHARGEABLE Charging battery with a usb cable.



BATTERY INCLUDED Set includes batteries.

TOWEL / PICNIC BLANKET



MICROFIBER Microfibre is a quick and super light synthetic material. It is resistant to tear and fraying. Towels made of microfibre are compact and fully absorb water.



QUICK DRY Synthetic materials of which the towels are made are pleasing to the touch and dry fast, which ensures comfort during leisure.



PACKED INTO A COVER Additional towel cover makes it easier to transport the towel.

BAGGAGE

BACKPACK / BAG ETC.



ERGONOMIC BACK Soft filling of the back panels ensures comfort and precise fit of the backpack, even under heavy load.



CARRYING SYSTEM Carrying system allowing for individual adjustment of braces, the hip and the chest belts.



SHIFT SYSTEM Back length adjustable to the backpack user's height.



AIR DRAFT SYSTEM Air Draft system applied in the back part of the backpack provides high air circulation, ensuring perfect control of heat and moisture, leaving your back dry during active outdoor recreation.



VERTICAL FLOW SYSTEM Back ventilation through a central air channel and mesh made of quick-drying material.



RAIN BAG COVER The rain cover hidden in the pocket on the bottom of the backpack effectively protects its contents from rain.



ORGANIZER Built-in pocket with multiple compartments is a perfect organiser for pens, notepad, and other small items.



LAPTOP POCKET Built-in laptop pocket or compartment.



ANTI-SCAN Safe pocket reduces the risk of scanning chips and proximity cards.



H2O SYSTEM Opening in the backpack for a tube enabling the use of a waterskin.



AUDIO SYSTEM Opening in the backpack or in the bag for a headphone cable, allowing the use of an mp3 player or other audio equipment.



GLASSES POCKET A special pocket for glasses, usually filled with a soft padding, protecting the glasses against scratching.



WHISTLE Built-in whistle increases safety during trips.



REFLECTIVE ELEMENTS Reflective elements increase safety during active leisure.

SUITCASE



ABS HARD SHELL Suitcase made in hard shell technology, using durable ABS.



PP HARDSHELL Suitcase made in hard shell technology, using PP which is more flexible and resistant to impact than ABS.



COMBINATION LOCK A code used in suitcases ensures protection of personal luggage against theft.



CABIN BAGGAGE A so-called cabin suitcase, that is a suitcase with the dimensions of hand luggage. Note: the dimensions of hand luggage vary depending on the airline.



360° WHEELS A system of wheels that allows you to rotate your suitcase around its axis.



MEN'S OUTDOOR SPRING/SUMMER 2023



MALASPINA II LIGHT JACKET

SIZE: S-XXL

MATERIAL COMPOSITION:
SHELL: 100% POLYESTER

SPECIFICATION:

- WATERPROOF 15 000 mm H₂O
- BREATHABILITY 10 000 g H₂O/m²
- 3L MEMBRANE
- DWR COATING
- WATERPROOF ZIPPERS
- TWO-SIDE ZIPPER
- TAPED SEAMS
- VENTILATION
- 3D HOOD REGULATION
- 3IN1 SYSTEM
- REFLECTIVE ELEMENTS



DRESS BLUES/OCEAN DEPTHS/SAFFRON

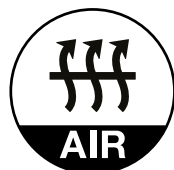
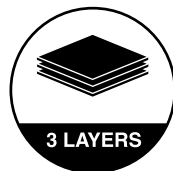

MAKAN SYMPATEX LIGHT JACKET

NEW PRODUCT

sympatex®

SIZE: S-XXL

MATERIAL COMPOSITION: SYMPATEX (100% PES)

SPECIFICATION:

- WINDPROOF
- 3-LAYER LAMINATION
- TAPED SEAMS
- DWR COATING
- YKK ZIPPER
- VENTILATION
- REFLECTIVE ELEMENTS

CERTIFICATES: OEKO-TEX



BLACK

WIND PROOF

3 LAYERS

TS

DWR

YKK ZIPPER

VENTILATION

WATER RESISTANT

OEKO-TEX®
CONFIDENCE IN TEXTILES
STANDARD 100
IW 00004 IW

Zbadane na substancje szkodliwe.
www.oeko-tex.com/standard100

LORIKO LIGHT JACKET

SIZE: S-XXL

MATERIAL COMPOSITION: 100% POLYESTER, PU MEMBRANE

SPECIFICATION:

- WATERPROOF: 10 000 mm H₂O
- BREATHABILITY: 10 000 g/H₂O/m²
- WINDPROOF
- 2,5-LAYER LAMINATION
- TAPED SEAMS
- SBS ZIPPER
- REFLECTIVE ELEMENTS
- ACTIVGUARD PRO TECHNOLOGY

CERTIFICATES: BLUESIGN

 **ActivGuard PRO**



ANTIQUE MOSS/WOODBINE

NEW PRODUCT

GANTORI LIGHT JACKET

SIZE: S-XXL

MATERIAL COMPOSITION:

SHELL: 100% POLYESTER

LINING: 100% POLYESTER

SPECIFICATION:

- WATERPROOF 10 000 mm H²O
- BREATHABILITY 5 000 g H²O/m²
- 2.5L MEMBRANE
- DWR COATING
- TAPED SEAMS
- REFLECTIVE ELEMENTS

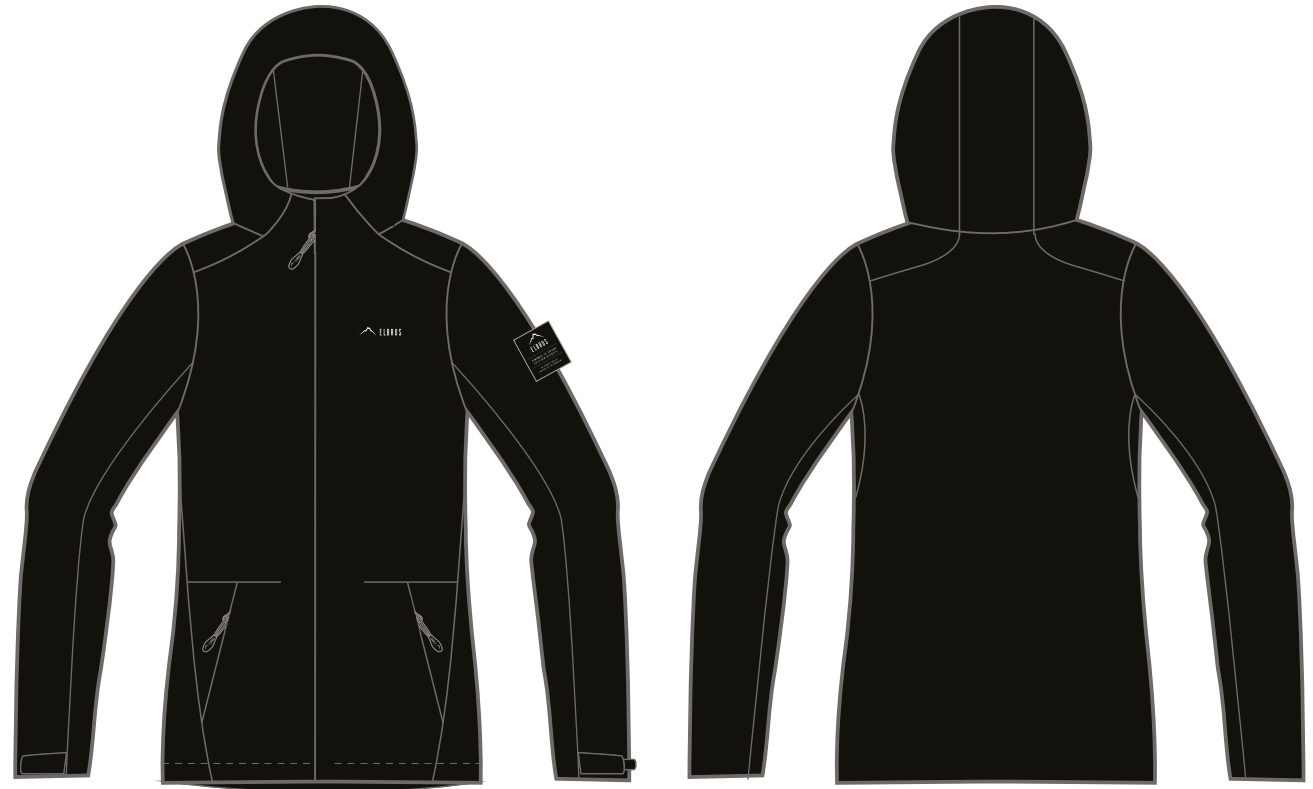

BLACK

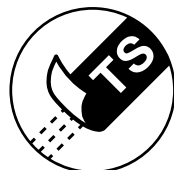

MAKARI LIGHT JACKET

SIZE: S-XXL

MATERIAL COMPOSITION:

SHELL: 100% POLYESTER

LINING: 100% POLYESTER

SPECIFICATION:

- WATERPROOF 10 000 mm H₂O
- BREATHABILITY 5 000 g H₂O/m²
- TAPED SEAMS
- VENTILATION
- REMOVABLE HOOD
- DWR COATING



DIRECTORIE BLUE/DRESS BLUES



VANDI II QUILTED JACKET

SIZE: S-XXL

MATERIAL COMPOSITION:

SHELL: 100% NYLON

LINING: 100% NYLON

FILLING: 100% POLYESTER, 160 g/m²

SPECIFICATION:

- RECYCLED PADDING

NEW PRODUCT

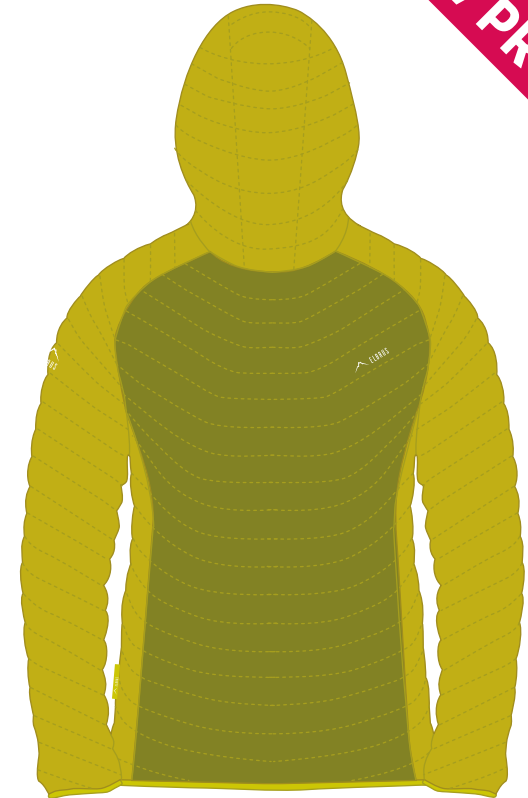

WOODBINE/ANTIQUE MOSS



 **EVERT** PADDED JACKET

SIZE: S-XXL

MATERIAL COMPOSITION:

SHELL: 100% NYLON / 100% POLYESTER

LINING: 100% NYLON

FILLING: 100% POLYESTER, 100 g/m²

SPECIFICATION:

- DWR COATING



BLACK BEAUTY/CHIPMUNK



ELIM PRIMALOFT PADDED JACKET



SIZE: S-XXL

MATERIAL COMPOSITION:

SHELL: 100% NYLON / 92% POLYESTER, 8%

ELASTANE, 230g/m²

LINING: 100% NYLON

FILLING: PRIMALOFT® SILVER INSULATION

THERMOPLUME® WITH CROSS CORE™
TECHNOLOGY

SPECIFICATION:

- MICROFLEECE LINED
- WELDED STITCHINGS
- REFLECTIVE ELEMENTS
- OEKO-TEX

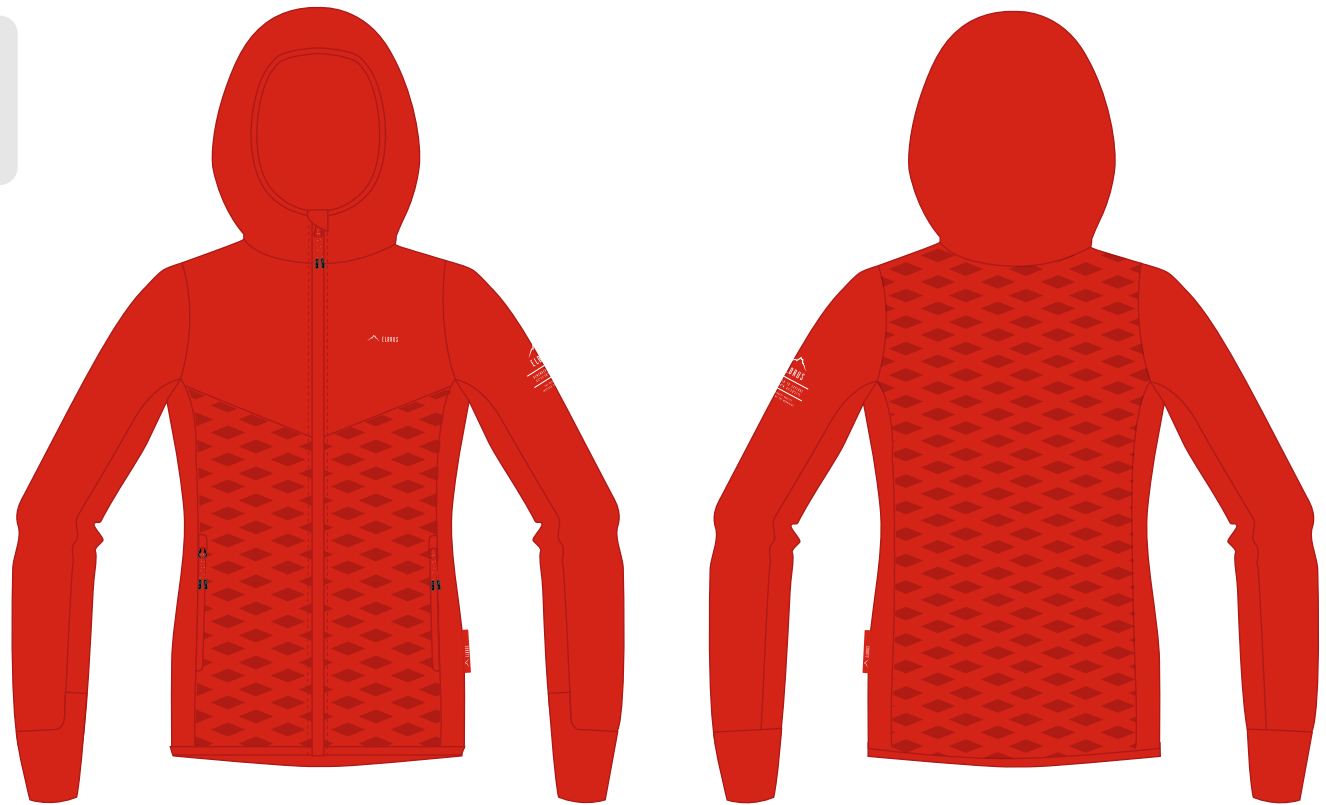

FLAME SCARLET



DIRRO PRIMALOFT LIGHT JACKET



SIZE: S-XXXL

MATERIAL COMPOSITION:

SHELL: 100% NYLON, 100% POLIESTER

LINING: 100% NYLON

FILLING: PRIMALOFT® SILVER INSULATION BIO,
100% POLYESTER, 100 g/m2

SPECIFICATION:

- WATER RESISTANT
- 2-LAYER LAMINATION
- DWR COATING
- SKIPASS POCKET
- REFLECTIVE ELEMENTS
- RECYCLED

CERTIFICATES: OEKO-TEX®



CITRONELLE / WOODBINE / BLACK

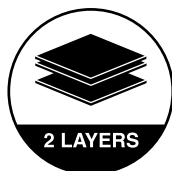

 **NAHAN** BLOUSE

SIZE: S-XXL

MATERIAL COMPOSITION:

SHELL: 94% POLYESTER, 6% ELASTIC / 100%

POLYESTER, 280 g/m²

SPECIFICATION:

- MICROFLEECE LINED



BLACK



EMIN II VEST PRIMALOFT PADDED VEST



SIZE: S-XXL

MATERIAL COMPOSITION:

SHELL: 100% NYLON / 92% POLYESTER, 8%

ELASTANE, 230g/m²

LINING: 100% NYLON

FILLING: PrimaLoft® Silver Insulation ThermoPlume®
with Cross Core™ Technology

SPECIFICATION:

- MICROFLEECE LINED
- WELDED STITCHINGS
- REFLECTIVE ELEMENTS
- OEKO-TEX



FLAME SCARLET / CHILI PEPPER



EMIN VEST PRIMALOFT QUILTED VEST



SIZE: S-XXL

MATERIAL COMPOSITION:

SHELL: 100% NYLON / 100% POLYESTER

LINING: 100% NYLON

FILLING: PRIMALOFT® GOLD INSULATION LUXE™

100% ECO

SPECIFICATION:

- DWR COATING
- MICROFLEECE LINED
- WELDED STITCHINGS
- VENTILATION
- 3IN SYSTEM
- RECYCLED PADDING
- BLUESIGN
- OEKO-TEX

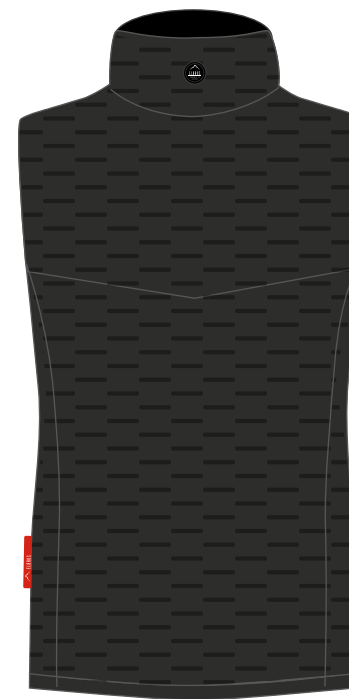
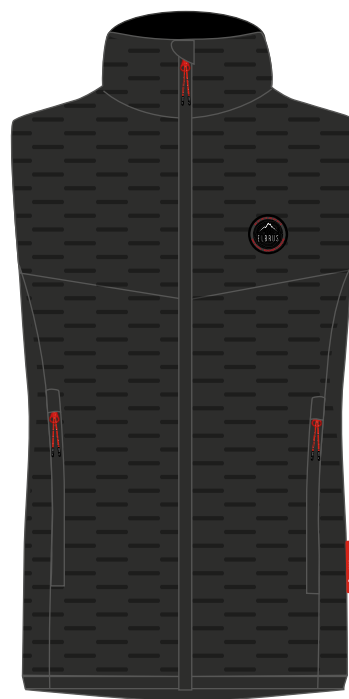

BLACK



EMIN VEST PRIMALOFT QUILTED VEST



SIZE: S-XXL

MATERIAL COMPOSITION: 100% NYLON,
PRIMALOFT SILVER, 152G

SPECIFICATION:

- DWR COATING
- SBS ZIPPER
- REMOVABLE HOOD

CERTIFICATES: BLUESIGN



BLACK

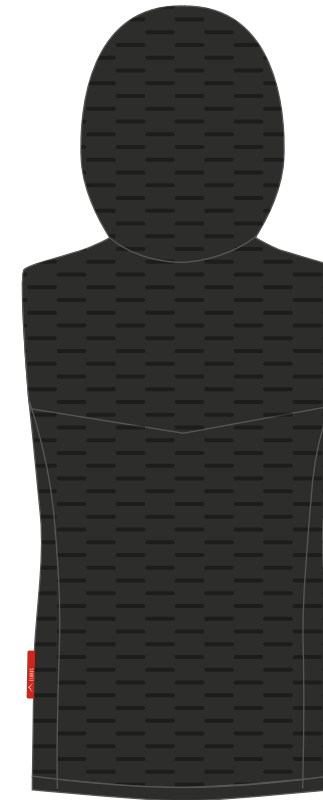

NEW PRODUCT



RAMAN PADDED VEST

SIZE: S-XXL

MATERIAL:

VEST: 96% POLYESTER, 4% ELASTANE, 100%

NYLON

FILLING: 100% POLYESTER, 120 g/m²

SPECIFICATION:

- REFLECTIVE ELEMENTS
- DWR COATING
- 4 WAY STRETCH



BLACK



RALPH II PADDED VEST

SIZE: S-XXL

MATERIAL:

VEST: 100% NYLON / 96% POLYESTER, 4%

ELASTANE

FILLING: 100% POLYESTER, 120 g/m²

SPECIFICATION:

- REFLECTIVE ELEMENTS
- DWR COATING
- 4 WAY STRETCH

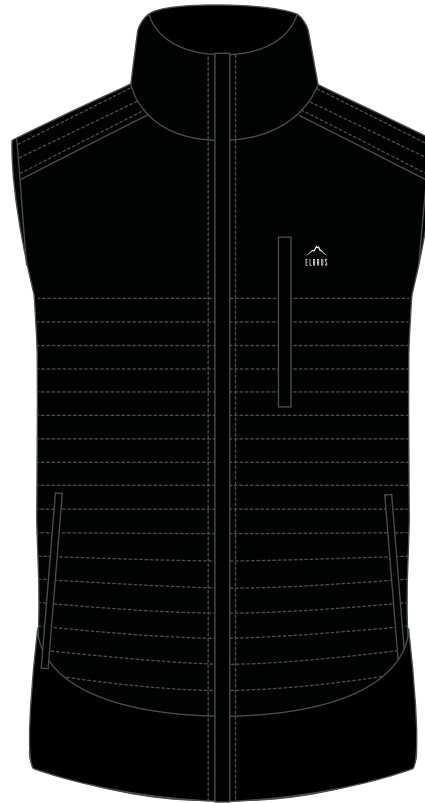

BLACK



SIZE: S-XXL

MATERIAL COMPOSITION: 100% POLYESTER

SPECIFICATION:

- WINDPROOF
- WATER REPELLENT
- VERSATILE MEBRANE
- RESILIENT STRETCH
- BREATHABLE
- HIGHLY DURABLE
- BLUESIGN
- OEKO-TEX



BLACK/PHANTOM



TOTAL ECLIPSE/TOTAL ECLIPSE

SETE SOFTSHELL

SIZE: S-XXL

MATERIAL COMPOSITION:

SHELL: 100% POLYESTER

LINING: 100% POLYESTER

SPECIFICATION:

- WATERPROOF 10 000 mm H²O

- BREATHABILITY 5 000 g H²O/m²

- 3L MEMBRANE

- VENTILATION

- MICROFLEECE LINED

- DWR COATING



DIRECTORIE BLUE / DRESS BLUES

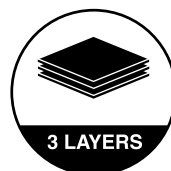

FLAME SCARLET/CHILI PEPPER/WHITE

SOGNE SOFTSHELL

SIZE: S-XXL

MATERIAL COMPOSITION:
SHELL: 100% POLYESTER
LINING: 100% POLYESTER

SPECIFICATION:
- WATERPROOF 10 000 mm H²O
- BREATHABILITY 5 000 g H²O/m²
- 3L MEMBRANE
- VENTILATION
- MICROFLEECE LINED
- DWR COATING



DIRECTOIRE BLUE/DRESS BLUES

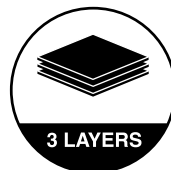

IHAR SOFTSHELL

SIZE: S-XXL

MATERIAL COMPOSITION:

SHELL: 94% POLYESTER, 6% ELASTANE

LINING: 100% POLYESTER

SPECIFICATION:

- WATERPROOF 8 000 mm H²O
- BREATHABILITY 1 000 g H²O/m²
- 3L MEMBRANE
- VENTILATION
- MICROFLEECE LINED
- 4 WAY STRETCH



BLACK BEAUTY / SAFFRON

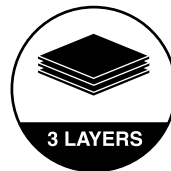

IFAR II SOFTSHELL

SIZE: S-XXL

MATERIAL COMPOSITION:

SHELL: 94% POLYESTER, 6% ELASTANE

LINING: 100% POLYESTER

SPECIFICATION:

- WATERPROOF 8 000 mm H²O
- BREATHABILITY 1 000 g H²O/m²
- 3L MEMBRANE
- 4 WAY STRETCH
- VENTILATION
- MICROFLEECE LINED



TOTAL ECLIPSE/TOTAL ECLIPSE

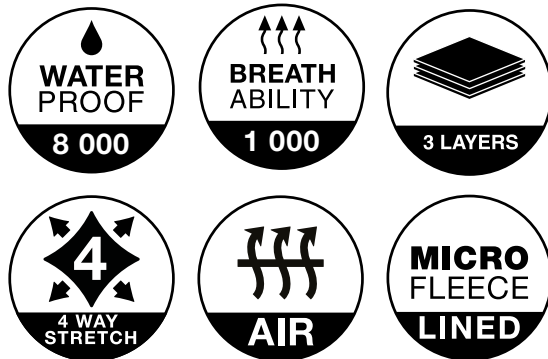

BLACK

IVER SOFTSHELL

SIZE: S-XXL

MATERIAL COMPOSITION:

SHELL: 94% POLYESTER, 6% ELASTANE

LINING: 100% POLYESTER

SPECIFICATION:

- WATERPROOF 8 000 mm H²O
- BREATHABILITY 1 000 g H²O/m²
- 3L MEMBRANE
- VENTILATION
- MICROFLEECE LINED
- 4 WAY STRETCH



TOTAL ECLIPSE/TOTAL ECLIPSE

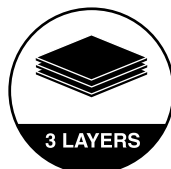

BLACK



BLACK/YELLOW GREEN



BLACK/SPICY ORANGE/ASPHALT

ENVISAT SOFTSHELL

SIZE: S-XXL

MATERIAL COMPOSITION:
SHELL: 100% POLYESTER
LINING: 100% POLYESTER

SPECIFICATION:
- WATERPROOF 10 000 mm H²O
- BREATHABILITY 5 000 g H²O/m²
- 3L MEMBRANE
- DWR COATING
- VENTILATION
- ELEMENTY ODBLASKOWE



DRESS BLUES/CLOISSONE

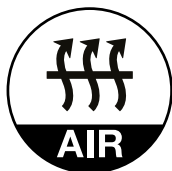

RALAND SOFTSHELL

SIZE: S-XXL

MATERIAL COMPOSITION:

SHELL: 100% POLYESTER

LINING: 100% POLYESTER

SPECIFICATION:

- WATERPROOF 10 000 mm H²O
- BREATHABILITY 3 000 g H²O/m²
- VENTILATION
- DWR COATING
- 4 WAY STRETCH
- 3 LAYERS MEMBRANE



DRESS BLUES/OCEAN DEPTHS/SAFFRON

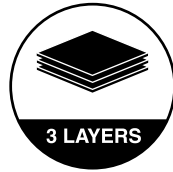

BLACK/PHANTOM

 **MAZE** FLEECE

SIZE: S-XXL

MATERIAL COMPOSITION:
SHELL: 100% POLYESTER, 350 g/m²



BLACK

CARLOW 190 POLARTEC FLEECE POLARTEC® 200 SERIES FLEECE



SIZE: S-XXL

MATERIAL:
FLEECE: 100% POLYESTER, 190 g/m²



BLACK



CHILI PEPPER



CARLOW 190 FLEECE

SIZE: S-XXL

MATERIAL COMPOSITION:
100% POLYESTER, 190 g/m2

CERTIFICATES: OEKO-TEX®



DRESS BLUES



DIRECTOIRE BLUE



CARI POLARTEC FLEECE POLARTEC® 100 SERIES FLEECE



SIZE: S-XXL

MATERIAL COMPOSITION: 100% POLYESTER,
195 g/m²

SPECIFICATION:

- SOFT COMFORT
- WARMTH WITHOUT WEIGHT
- HIGHLY BREATHABLE
- DURABLE
- RECYCLED
- BLUESIGN
- OEKO-TEX



DRESS BLUES/CLOISSONE

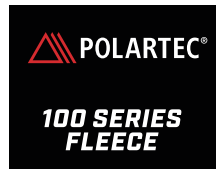

CITRONELLE/BLACK

CARI POLARTEC 1/2 FLEECE POLARTEC® 100 SERIES FLEECE



SIZE: S-XXL

MATERIAL COMPOSITION: 100% POLYESTER,
195g/m²

SPECIFICATION:

- SOFT COMFORT
- WARMTH WITHOUT WEIGHT
- HIGHLY BREATHABLE
- DURABLE
- RECYCLED
- BLUESIGN
- OEKO-TEX



FLAME SCARLET/CHILI PEPPER

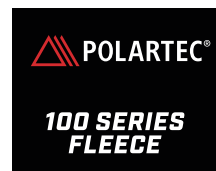

BLACK

EMINO POLARTEC BLOUSE POLARTEC® POWER STRETCH® PRO™



POLARTEC®

SIZE: S-XXL

MATERIAL COMPOSITION: 52% POLYESTER, 31%
NYLON, 17% LYCRA

SPECIFICATION:

- DUAL-SURFACE
- 4 WAY STRETCH
- SUPERIOR ABRASION RESISTANCE
- SHAPE RETENTION
- HIGHLY BREATHABLE
- WICKS MOISTURE
- MICROFLEECE LINED
- BLUESIGN
- OEKO-TEX



CHILI PEPPER/FLAME SCARLET



 **BESSAN POLARTEC** BLOUSE POLARTEC® POWER GRID™



SIZE: S-XXL

MATERIAL COMPOSITION: 100% POLYESTER

SPECIFICATION:

- SOFT COMFORT
- WARMTH WITHOUT WEIGHT
- HIGHLY BREATHABLE
- DURABLE
- RECYCLED
- BLUESIGN
- OEKO-TEX



BLACK / PHANTOM



BESSAN BLOUSE

SIZE: S-XXL

MATERIAL COMPOSITION: 100% POLYESTER

SPECIFICATION:

- SOFT COMFORT
- WARMTH WITHOUT WEIGHT
- HIGHLY BREATHABLE
- DURABLE
- RECYCLED

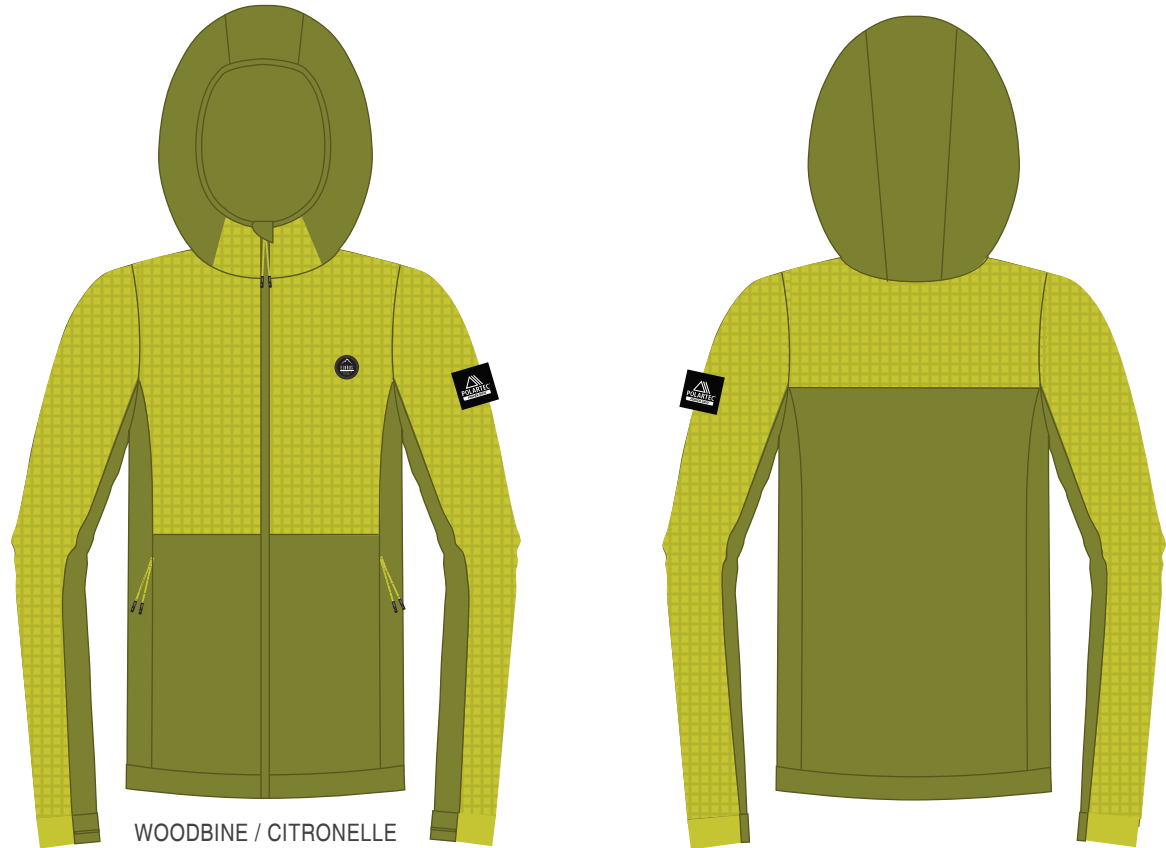

NADIM POLARTEC BLOUSE POLARTEC® POWER GRID™



SIZE: S-XXL

MATERIAL COMPOSITION: 100% POLYESTER

SPECIFICATION:

- SOFT COMFORT
- WARMTH WITHOUT WEIGHT
- HIGHLY BREATHABLE
- DURABLE
- RECYCLED
- BLUESIGN
- OEKO-TEX



BLACK



GAUDE POLARTEC WINDBLOCK PANTS POLARTEC® WINDBLOCK



POLARTEC®

SIZE: S-XXL

MATERIAL COMPOSITION: 100% POLYESTER

SPECIFICATION:

- WINDPROOF
- WATER REPELLENT
- VERSATILE MEBRANE
- RESILIENT STRETCH
- BREATHABLE
- HIGHLY DURABLE
- BLUESIGN
- OEKO-TEX

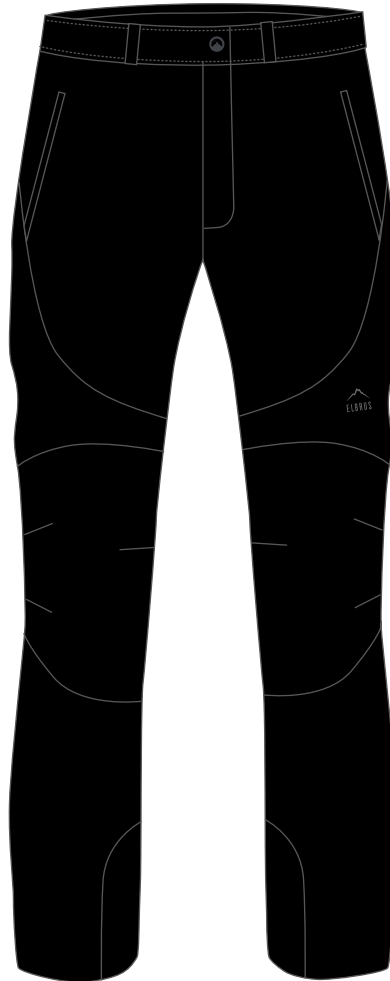

BLACK

 POLARTEC®
WINDBLOC®

 bluesign®

OEKO-TEX®
CONFIDENCE IN TEXTILES
STANDARD 100 
IW 00004 IW
Zbadane na substancje szkodliwe.
www.oeko-tex.com/standard100

MORIT LIGHT PANTS

SIZE: S-XXL

MATERIAL COMPOSITION: 100% POLYESTER

SPECIFICATION:

- WATERPROOF 15 000 mm H²O
- BREATHABILITY 10 000 g H²O/m²
- 3-LAYER LAMINATION
- TAPED SEAMS
- WATERPROOF ZIPPER
- DWR COATING
- REFLECTIVE ELEMENTS

CERTIFICATES: OEKO-TEX

NEW PRODUCT



BLACK

ActivGuard
PRO

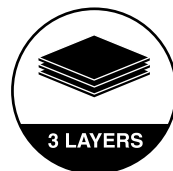

Zbadane na substancje szkodliwe.
www.oeko-tex.com/standard100

GARII LIGHT PANTS

SIZE: S-XXL

MATERIAL COMPOSITION: 100% POLYESTER, PU
MEMBRANE

SPECIFICATION:

- WATERPROOF: 10 000 mm H₂O
- BREATHABILITY: 10 000 g/H₂O/m²
- WINDPROOF
- 2,5 LAYER LAMINATION
- TAPED SEAMS
- SBS ZIPPER
- REFLECTIVE ELEMENTS
- ACTIVGUARD PRO TECHNOLOGY

CERTIFICATES: OEKO-TEX, BLUESIGN

 **ActivGuard
PRO**

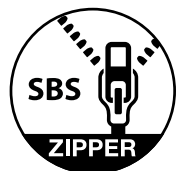

BLACK / ANTIQUE MOSS

NEW PRODUCT

AMBORO OUTDOOR PANTS

SIZE: S-XXL

MATERIAL COMPOSITION:
SHELL: 100% POLYESTER

SPECIFICATION:
- WATERPROOF: 10000 mm H₂O
- BREATHABILITY: 5000 g/H₂O/m²
- WATER RESISTANT
- 2-LAYER LAMINATION
- DWR COATING
- REFLECTIVE ELEMENTS

CERTIFICATES: OEKO-TEX®

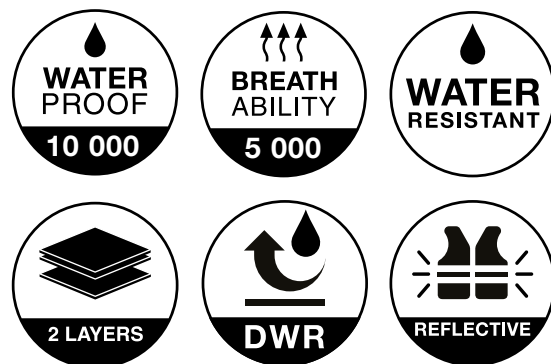

CHILLI PEPPER

 **GAUDE** SOFTSHELL PANTS

SIZE: S-XXL

MATERIAL COMPOSITION:
SHELL: 93% NYLON, 7% ELASTANE

SPECIFICATION:
- DWR COATING

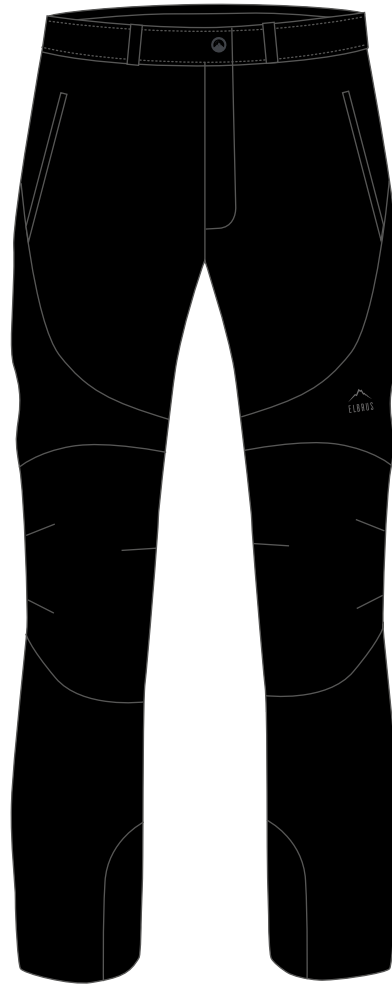

BLACK

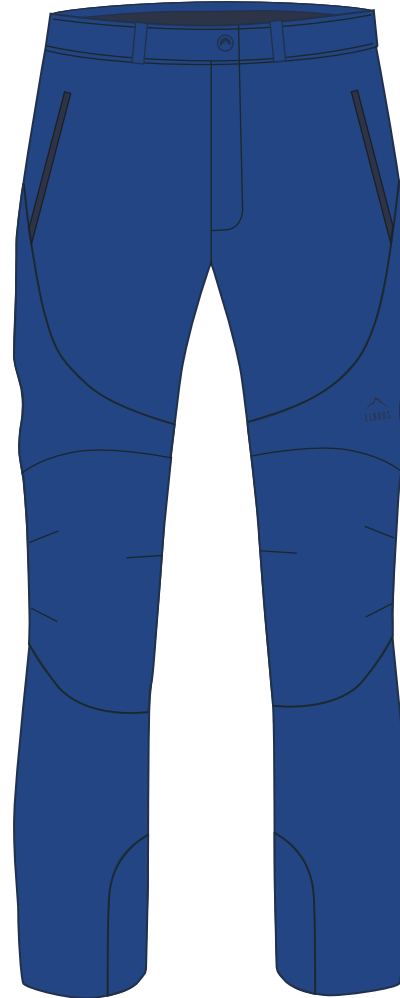

CLASSIC BLUE/DRESS BLUES

PALMAR 1/2 SHORTS

SIZE: XS-XL

MATERIAL COMPOSITION:
90% NYLON, 10% ELASTANE

SPECIFICATION:

- DWR COATING
- SBS ZIPPER
- 4 WAY STRETCH
- REFLECTIVE ELEMENTS

CERTIFICATION: OEKO-TEX



BLACK / ANTIQUE MOSS

NEW PRODUCT



ARNE 1/2 SHORTS

SIZE: S-XXL

MATERIAL COMPOSITION:
SHELL: 90% NYLON, 10% ELASTANE

- SPECIFICATION:
- 4 WAY STRETCH
 - QUICK DRY
 - REFLECTIVE ELEMENTS

NEW PRODUCT



WOODBINE/ANTIQUE MOSS



WOODBINE / CITRONELLE

WOMEN'S OUTDOOR SPRING/SUMMER 2023



MALASPINA WO'S SYMPATEX LIGHT JACKET

NEW PRODUCT

sympatex®

SIZE: XS-XL

MATERIAL COMPOSITION: SYMPATEX (100% PES)

SPECIFICATION:

- WINDPROOF
- 3-LAYER LAMINATION
- TAPED SEAMS
- DWR COATING
- YKK ZIPPER
- VENTILATION
- REFLECTIVE ELEMENTS

CERTIFICATES: OEKO-TEX



BLACK

WIND PROOF

3 LAYERS

TS

DWR

YKK ZIPPER

VENTILATION

REFLECTIVE

OEKO-TEX®
CONFIDENCE IN TEXTILES
STANDARD 100
IW 00004 IW

Zbadane na substancje szkodliwe.
www.oeko-tex.com/standard100

MALASPINA II WO'S LIGHT JACKET

SIZE: XS-XL

MATERIAL COMPOSITION:
SHELL: 100% POLYESTER

SPECIFICATION:

- WATERPROOF 15 000 mm H₂O
- BREATHABILITY 10 000 g H₂O/m²
- 3L MEMBRANE
- DWR COATING
- WATERPROOF ZIPPERS
- TWO-SIDE ZIPPER
- TAPED SEAMS
- VENTILATION
- 3D HOOD REGULATION
- 3IN1 SYSTEM
- REFLECTIVE ELEMENTS



ELDERBERRY



GANTORI WO`S LIGHT JACKET

SIZE: XS-XL

MATERIAL COMPOSITION:

SHELL: 100% POLYESTER

LINING: 100% POLYESTER

SPECIFICATION:

- WATERPROOF 10 000 mm H²O
- BREATHABILITY 5 000 g H²O/m²
- 2.5L MEMBRANE
- TAPED SEAMS



MIDNIGHT NAVY

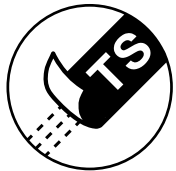

MAKARI WO'S LIGHT JACKET

SIZE: XS-XL

MATERIAL COMPOSITION:

SHELL: 100% POLYESTER, TPU MEMBRANE

LINING: 100% POLYESTER

SPECIFICATION:

- WATERPROOF: 10 000 mm H₂O
- BREATHABILITY: 5 000 g/H₂O/m²
- 2-LAYER LAMINATION
- TAPED SEAMS
- SBS ZIPPER
- REMOVABLE HOOD
- REFLECTIVE ELEMENTS
- ACTIVGUARD PLUS TECHNOLOGY

CERTIFICATES: OKEO-TEX

NEW PRODUCT



MAGENTA

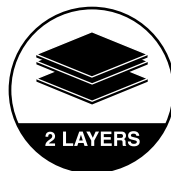

MIDNIGHT NAVY/BRIDAL ROSE

EVERTON WO`S SOFTSHELL / QUILTED JACKET

SIZE: XS-XL

MATERIAL COMPOSITION:

SHELL: 100% NYLON, 92% POLYESTER, 8%

ELASTANE

LINING: 100% NYLON

FILLING: 100% POLYESTER, 100 g/m²

SPECIFICATION:

- WATER RESISTANT
- 2-LAYER LAMINATION
- DWR COATING

CERTIFICATES: OEKO-TEX®



BLUE NIGHTS/ELDELBERRY



ELIMA PRIMALOFT WO`S PADDED JACKET

 **PRIMALOFT®**

SIZE: XS-XL

MATERIAL COMPOSITION:

SHELL: 100% NYLON / 92% POLYESTER, 8%

ELASTANE, 230g/m²

LINING: 100% NYLON

FILLING: PRIMALOFT® SILVER INSULATION

THERMOPLUME® WITH CROSS CORE™

TECHNOLOGY

SPECIFICATION:

- MICROFLEECE LINED
- WELDED STITCHINGS
- 3IN SYSTEM
- REFLECTIVE ELEMENTS
- OEKO-TEX



HIBISCUS



JULIMAR II WO`S PRIMALOFT QUILTED JACKET

 **PRIMALOFT®**

SIZE: XS-XL

MATERIAL COMPOSITION:

SHELL: 100% NYLON / 100% POLYESTER

LINING: 100% NYLON

FILLING: PRIMALOFT® SILVER INSULATION LUXE

100% ECO

SPECIFICATION:

- DWR COATING
- MICROFLEECE LINED
- WELDED STITCHINGS
- VENTILATION
- 3IN SYSTEM
- REFLECTIVE ELEMENTS
- RECYCLED PADDING
- BLUESIGN
- OEKO-TEX



PLUM PURPLE



EMIN II PRIMALOFT WO'S PADDED JACKET



SIZE: XS-XL

MATERIAL COMPOSITION:

SHELL: 100% NYLON / 92% POLYESTER, 8%

ELASTANE, 230g/m²

LINING: 100% NYLON

FILLING: PRIMALOFT® BLACK INSULATION

SPECIFICATION:

- MICROFLEECE LINED
- VENTILATION
- 3IN SYSTEM
- REFLECTIVE ELEMENTS
- OEKO-TEX



BLACK PLUM

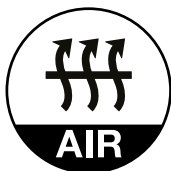

NAHAN WO'S BLOUSE

SIZE: XS-XL

MATERIAL COMPOSITION:

SHELL: 94% POLYESTER, 6% ELASTIC / 100%

POLYESTER, 280 g/m²

SPECIFICATION:

- MICROFLEECE LINED



BLACK



ARAPO II WO'S QUILTED VEST

SIZE: XS-XL

MATERIAL COMPOSITION:

SHELL: 100% NYLON

LINING: 100% POLYESTER

FILLING: 100% POLYESTER, 160 g/m²

SPECIFICATION:

- WATER RESISTANT
- 2-LAYER LAMINATION
- DWR COATING
- REFLECTIVE ELEMENTS

CERTIFICATES: OEKO-TEX®

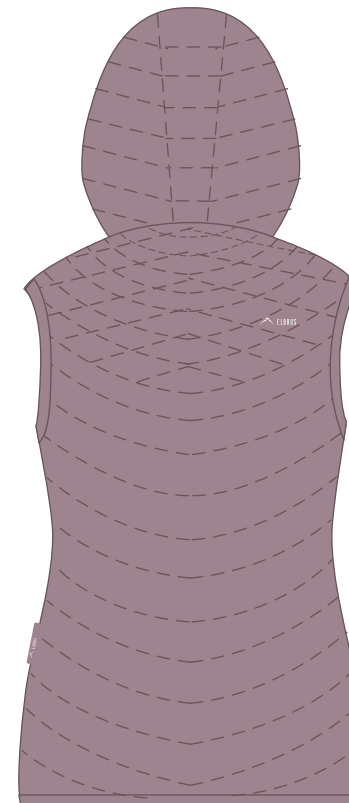

ELDERBERRY

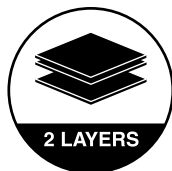

IFARO WO`S POLARTEC SOFTSHELL POLARTEC® WINDBLOC®



SIZE: XS-XL

MATERIAL COMPOSITION: 100% POLYESTER

SPECIFICATION:

- WINDPROOF
- WATER REPELLENT
- VERSATILE MEBRANE
- RESILIENT STRETCH
- BREATHABLE
- HIGHLY DURABLE
- BLUESIGN
- OEKO-TEX



WINETASTING



SIGNES WO`S SOFTSHELL

SIZE: XS-XL

MATERIAL COMPOSITION:

SHELL: 94% POLYESTER, 6% ELASTANE

SPECIFICATION:

- WATERPROOF: 10000 mm H₂O
- BREATHABILITY: 3000 g/H₂O/m²
- WINDPROOF
- WATER RESISTANT
- 2-LAYER LAMINATION
- DWR COATING
- VENTILATION
- REMOVABLE HOOD
- THUMB HOLES
- REFLECTIVE ELEMENTS
- MICROFLEECE LINED

CERTIFICATES: OEKO-TEX®



ELDERBERRY / BLUE NIGHTS

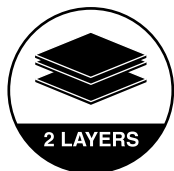

ENVISAT WO`S SOFTSHELL

SIZE: S-XL

MATERIAL COMPOSITION:

SHELL: 100% POLYESTER

LINING: 100% POLYESTER

SPECIFICATION:

- WATERPROOF 10 000 mm H²O
- BREATHABILITY 5 000 g H²O/m²
- 3L MEMBRANE
- DWR COATING
- VENTILATION
- ELEMENTY ODBLASKOWE



SKI PATROL MELANGE/HIBISCUS/BLUE BIRD

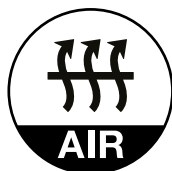

IVER WO`S SOFTSHELL

SIZE: XS-XL

MATERIAL COMPOSITION:

SHELL: 94% POLYESTER, 6% ELASTANE

LINING: 100% POLYESTER

SPECIFICATION:

- WATERPROOF 8 000 mm H²O
- BREATHABILITY 1 000 g H²O/m²
- 3L MEMBRANE
- 4 WAY STRETCH
- VENTILATION
- MICROFLEECE LINED



BLACK / SPICY ORANGE / ASPHALT

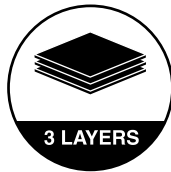

MELBA II WO`S SOFTSHELL

SIZE: S-XL

MATERIAL COMPOSITION:

SHELL: 94% POLYESTER, 6% ELASTANE

LINING: 100% POLYESTER

SPECIFICATION:

- WATERPROOF 8 000 mm H²O
- BREATHABILITY 1 000 g H²O/m²
- 3L MEMBRANE
- DWR COATING
- 4 WAY STRETCH
- VENTILATION
- MICROFLEECE LINED
- REFLECTIVE ELEMENTS



TOTAL ECLIPSE



 **MAZE 350 WO'S** FLEECE

SIZE: XS-XL

MATERIAL COMPOSITION:
SHELL: 100% POLYESTER, 190 g/m²



BLACK

RIVOLI 190 WO'S POLARTEC® 200 SERIES FLEECE

 POLARTEC®

SIZE: XS-XL

MATERIAL COMPOSITION: 100% POLYESTER

SPECIFICATION:

- SOFT COMFORT
- WARMTH WITHOUT WEIGHT
- HIGHLY BREATHABLE
- DURABLE
- RECYCLED
- BLUESIGN
- OEKO-TEX



BLACK



 **RIVOLI 190 WO'S** FLEECE

SIZE: XS-XL

MATERIAL COMPOSITION:
SHELL: 100% POLYESTER, 190 g/m²



OPAL



TOTAL ECLIPSE/BLUE BIRD

 **RIVOLI WO'S II** FLEECE

SIZE: XS-XL

MATERIAL COMPOSITION:
SHELL: 100% POLYESTER, 190 g/m²



PARADISE PINK/CERISE

RIVA POLARTEC WO`S FLEECE POLARTEC® 100 SERIES FLEECE



SIZE: XS-XL

MATERIAL COMPOSITION: 100% POLYESTER, 195 g/m²

SPECIFICATION:

- SOFT COMFORT
- WARMTH WITHOUT WEIGHT
- HIGHLY BREATHABLE
- DURABLE
- RECYCLED
- BLUESIGN
- OEKO-TEX



FLAMINGO PINK

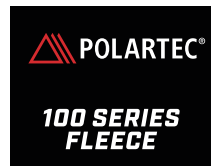

BLACK

RIVA POLARTEC 1/2 WO`S FLEECE POLARTEC® 100 SERIES FLEECE



SIZE: XS-XL

MATERIAL COMPOSITION: 100% POLYESTER, 159 g/m²

SPECIFICATION:

- SOFT COMFORT
- WARMTH WITHOUT WEIGHT
- HIGHLY BREATHABLE
- DURABLE
- RECYCLED
- BLUESIGN
- OEKO-TEX



ELDERBERRY / BLACK PLUM

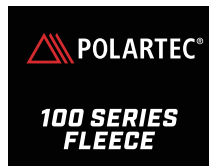

HIBISCUS / SKI PATROL

 **ARAVIS WO'S II** FLEECE

SIZE: XS-XL

MATERIAL COMPOSITION:
SHELL: 100% POLYESTER, 190 g/m²



TRIBE PRINT/PEARLED IVORY



EMINO WO`S POLARTEC

BLOUSE POLARTEC® POWER STRETCH® PRO™



SIZE: XS-XL

MATERIAL COMPOSITION: 52% POLYESTER, 31% NYLON, 17% LYCRA

SPECIFICATION:

- DUAL-SURFACE
- 4 WAY STRETCH
- SUPERIOR ABRASION RESISTANCE
- SHAPE RETENTION
- HIGHLY BREATHABLE
- WICKS MOISTURE
- MICROFLEECE LINED
- BLUESIGN
- OEKO-TEX



HIBISCUS/SKI PATROL/BLUE BIRD



BENNA POLARTEC WO`S BLOUSE POLARTEC® POWER GRID



SIZE: XS-XL

MATERIAL COMPOSITION: 93% POLYESTER, 7% SPANDEX

SPECIFICATION:

- BI-COMPONENT KNIT
- EFFICIENT PERFORMANCE
- VERSATILE WARMTH
- HIGHLY BREATHABLE
- MOISTURE WICKING
- LIGHTWEIGHT
- BLUESIGN
- OEKO-TEX



BLACK



BENNA WO`S BLOUSE

SIZE: XS-XL

MATERIAL COMPOSITION:

SHELL: 93% POLYESTER, 7% ELASTANE / 100%

POLYESTER, 240 g/m²

SPECIFICATION:

- MICROFLEECE LINED



FLAMINGO PINK



NADIM WO'S POLARTEC BLOUSE POLARTEC® POWER GRID™

 **POLARTEC®**

SIZE: XS-XL

MATERIAL COMPOSITION: 93% POLYESTER, 7% SPANDEX

SPECIFICATION:

- BI-COMPONENT KNIT
- EFFICIENT PERFORMANCE
- VERSATILE WARMTH
- HIGHLY BREATHABLE
- MOISTURE WICKING
- LIGHTWEIGHT
- BLUESIGN
- OEKO-TEX



BLACK

 **POLARTEC®**

POWER GRID™

 bluesign®

OEKO-TEX®
CONFIDENCE IN TEXTILES
STANDARD 100
IW 00004 IW

Zbadane na substancje szkodliwe.
www.oeko-tex.com/standard100

GAUDE WO'S POLARTEC WINDBLOCK PANTS POLARTEC® WIND BLOCK

 **POLARTEC®**

SIZE: XS-XL

MATERIAL COMPOSITION: 100% POLYESTER

SPECIFICATION:

- WINDPROOF
- WATER REPELLENT
- VERSATILE MEBRANE
- RESILIENT STRETCH
- BREATHABLE
- HIGHLY DURABLE
- BLUESIGN
- OEKO-TEX

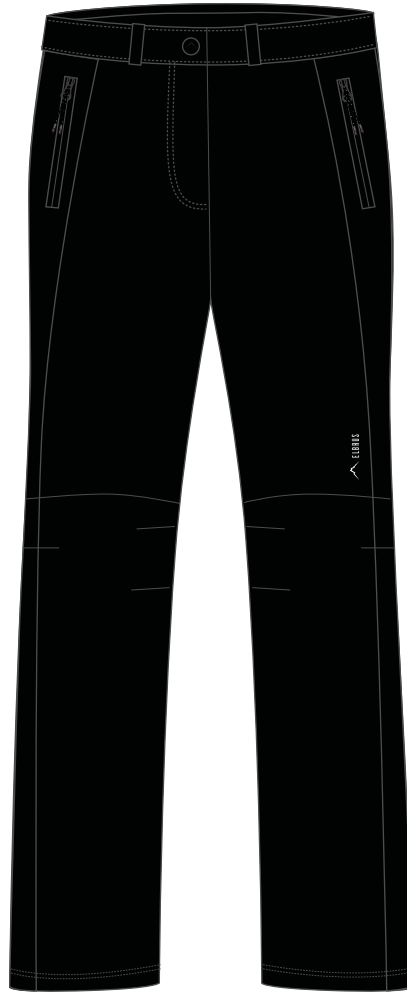

BLACK



 **GAUDE WO'S** OUTDOOR PANTS

SIZE: XS-XL

MATERIAL COMPOSITION:
SHELL: 93% NYLON, 7% ELASTANE

SPECIFICATION:
- DWR COATING



GREEN GABLES

MORIT WO'S LIGHT PANTS

SIZE: XS-XL

MATERIAL COMPOSITION: 100% POLYESTER

SPECIFICATION:

- WATERPROOF 15 000 mm H²O
- BREATHABILITY 10 000 g H²O/m²
- 3-LAYER LAMINATION
- TAPED SEAMS
- WATERPROOF ZIPPER
- DWR COATING
- REFLECTIVE ELEMENTS

CERTIFICATES: OEKO-TEX

NEW PRODUCT



BLACK

 **ActivGuard**
PRO

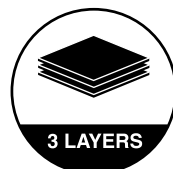

CECILIA WO'S LIGHT PANTS

SIZE: XS-XL

MATERIAL COMPOSITION: 90% NYLON, 10% ELASTANE

SPECIFICATION:

- DWR COATING
- SBS ZIPPER
- REFLECTIVE ELEMENTS

CERTIFICATES: OEKO-TEX

NEW PRODUCT



GRAYSTONE / ELDELBERRY



WINTER BLOOM

CECILIA SHORTS WO'S SHORTS

SIZE: XS-XL

MATERIAL COMPOSITION: 90% NYLON, 10% ELASTANE

SPECIFICATION:

- DWR COATING
- SBS ZIPPER
- REFLECTIVE ELEMENTS

CERTIFICATES: OEKO-TEX

NEW PRODUCT



GRAYSTONE/ELDERBERRY



TOTAL ECLIPSE



PALMAR SKIRT WO'S SKIRT

SIZE: XS-XL

MATERIAL COMPOSITION: 90% NYLON, 10% ELASTANE

SPECIFICATION:

- DWR COATING
- SBS ZIPPER
- 4 WAY STRETCH
- REFLECTIVE ELEMENTS

CERTIFICATES: OEKO-TEX

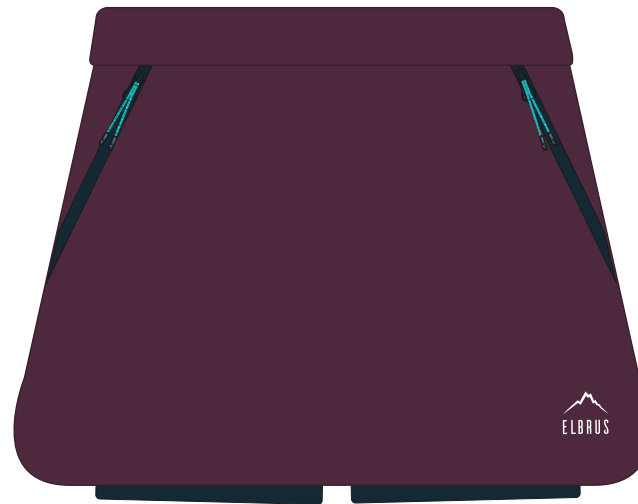

WINTER BLOOM/TOTAL ECLIPSE/BLUE BIRD

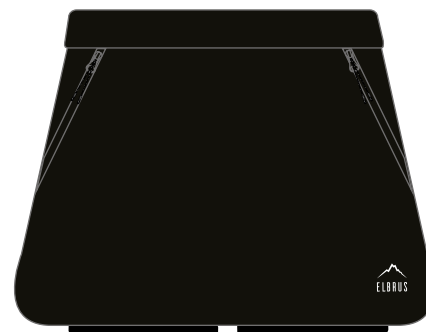

BLACK

JUNIOR'S OUTDOOR SPRING/SUMMER 2023



POUL TB LIGHT JACKET

SIZE: 152-164

MATERIAL COMPOSITION:

SHELL: 100% POLYESTER

LINING: 100% POLYESTER

SPECIFICATION:

- WATERPROOF 5 000 mm H²O
- BREATHABILITY 5 000 g H²O/m²
- TAPED SEAMS
- VENTILATION
- REMOVABLE HOOD
- DWR COATING



TANGERINE TANGO/BLACK

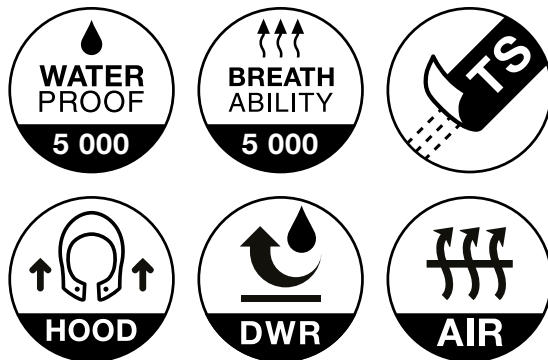

EMINI TB PADDED JACKET

SIZE: 152-164

MATERIAL COMPOSITION:

SHELL: 100% NYLON / 100% POLYESTER

LINING: 100% NYLON

FILLING: 100% POLYESTER

SPECIFICATION:

- DWR COATING
- MICROFLEECE LINED
- WELDED STITCHINGS
- RECYCLED PADDING



CITRONELLE/BLACK



CADMIUM YELLOW/BLACK

CARLOW TB FLEECE

SIZE: 152-164

MATERIAL COMPOSITION:
100% POLYESTER, 190 g/m²

CERTIFICATES: OEKO-TEX®



CADMIUM YELLOW



GAUDE TB OUTDOOR PANTS

SIZE: 152-164

MATERIAL COMPOSITION:
SHELL: 93% NYLON, 7% ELASTANE

SPECIFICATION:
- DWR COATING
- REFLECTIVE ELEMENTS



BLACK

MAKARI JRG LIGHT JACKET

NEW PRODUCT

SIZE:

MATERIAL:

JACKET: 100% POLYESTER

LINING: 100% POLYESTER

SPECIFICATION:

- WATERPROOF 3 000 mm H²O
- BREATHABILITY 3 000 g H²O/m²
- WATERPROOF ZIPPER
- TAPED SEAMS
- RIP STOP
- VENTILATION
- REMOVABLE HOOD



PANDEROSA PINE/JUNGLE PRINT



EMINI TG PADDED JACKET

SIZE: 152-164

MATERIAL COMPOSITION:

SHELL: 100% NYLON / 100% POLYESTER

LINING: 100% NYLON

FILLING: 100% POLYESTER

SPECIFICATION:

- DWR COATING
- MICROFLEECE LINED
- WELDED STITCHINGS
- RECYCLED PADDING



PANDEROSA PINE/JUNGLE PRINT



GAUDE TG OUTDOOR PANTS

SIZE: 152-164

MATERIAL COMPOSITION:
SHELL: 93% NYLON, 7% ELASTANE

SPECIFICATION:
- DWR COATING
- REFLECTIVE ELEMENTS

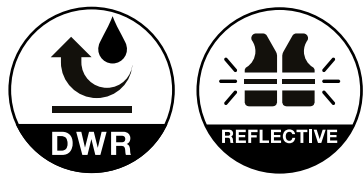

BAYBERRY

MEN'S COTTON SPRING/SUMMER 2023



REINAR BLOUSE

SIZE: S-XXL

MATERIAL COMPOSITION:
60% COTTON 40% POLYESTER
300 g/m2

SPECIFICATION:
- MICROFLEECE LINED



CHINESE RED



SAFFRON

 **RUFO** SWEATSHIRT

SIZE: S-XXL

MATERIAL COMPOSITION:

60% COTTON

40% POLYESTER

300 g FLEECE



BLACK



DEEP TEAL

 **VIRAN** SWEATSHIRT

SIZE: S-2XL

MATERIAL COMPOSITION: 70% POLYESTER,
30% COTTON, 280 g/m²



BLACK

NEW PRODUCT

 **CHIANO** SWEATSHIRT

SIZE: M-XXL

MATERIAL COMPOSITION:

80% COTTON

20% POLYESTER

320G FLEECE



DARK GREY/BLACK

 **NAPO** T-SHIRT

SIZE: M-XXL

MATERIAL COMPOSITION:
100% COTTON, 175 g/m²



BLACK

ANDREI T-SHIRT

SIZE: S-2XL

MATERIAL COMPOSITION:
100% ORGANIC COTTON ,175 g/m²



DRESS BLUES



NEW PRODUCT

ASMAR T-SHIRT

SIZE: S-2XL

MATERIAL COMPOSITION:
100% ORGANIC COTTON ,175 g/m²

NEW PRODUCT



CHILI PEPPER RED



WHITE



DORINI T-SHIRT

SIZE: S-XXL

MATERIAL COMPOSITION:
100% COTTON, 175 g/m²
ORGANIC COTTON



WHITE



DEEP TEAL

LUKANO T-SHIRT

SIZE: S-XXL

MATERIAL COMPOSITION:
100% COTTON, 175 g/m²
ORGANIC COTTON



WHITE



BLACK



TOTAL ECLIPSE

 **RIMA II** T-SHIRT

SIZE: M-XXL

MATERIAL COMPOSITION:
100% COTTON, 175 g/m²



LIME PUNCH MELANGE

 **RIMA III** T-SHIRT

SIZE: M-XXL

MATERIAL COMPOSITION:
100% COTTON, 175 g/m²



JUNE BUG

LORETO T-SHIRT

SIZE: M-XXL

MATERIAL COMPOSITION:
100% COTTON, 175g/m2

SPECIFICATION:
- ORGANIC COTTON



DRESS BLUES



BLACK

ROLF SWEAT PANTS

SIZE: S-XXL

MATERIAL COMPOSITION:
60% COTTON, 40% POLYESTER, 300g/m2

SPECIFICATION:
- MICROFLEECE LINED



CHINESE RED

BLACK

 **REGIN** SWEAT PANTS

SIZE: S-2XL

MATERIAL COMPOSITION: 70% POLYESTER,
30% COTTON, 280 g/m²

NEW PRODUCT

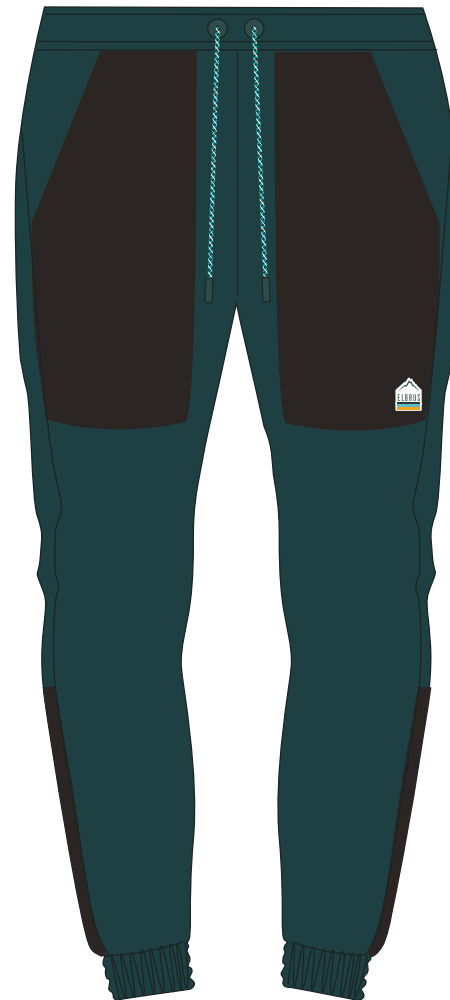

DEEAP TEAL/BLACK



BLACK

 **NIVAR** SWEAT PANTS

SIZE: S-XXL

NEW PRODUCT



LIGHT BLUE

 **MIKEL** SWEAT SHORTS

SIZE: S-2XL

MATERIAL COMPOSITION: 60% COTTON,
40% POLYESTER, 300 g/m²

NEW PRODUCT



WOODBINE



BLACK

WOMEN'S COTTON SPRING/SUMMER 2023



 **RIVIA II WO'S** HOODIE

SIZE: XS-XL

MATERIAL COMPOSITION:
60% COTTON 40% POLYESTER
300 g/m2

SPECIFICATION:
- MICROFLEECE LINED



BEIDAL ROSE



RUNA WO'S HOODIE

SIZE: XS-XL

MATERIAL COMPOSITION: 60% POLYESTER, 40% COTTON, 300 g/m2

- MICROFLEECE LINED



TOTAL ECLIPSE/CHERRY BLOSSOM



BAYBERRY

DAGNA WO'S HOODIE

SIZE: XS-XL

MATERIAL COMPOSITION:
100% ORGANIC COTTON ,175 g/m²

NEW PRODUCT



GRAY BLUE



SVEA WO'S HOODIE

SIZE: XS-XL

MATERIAL COMPOSITION: 100%
COTTON, 175 g/m2

- ORGANIC COTTON



CHERRY BLOSSOM



WHITE

METTE WO'S HOODIE

SIZE: XS-XL

MATERIAL COMPOSITION:

SHELL: 60% COTTON, 40% POLYESTER, 300 g/m²

ORGANIC COTTON

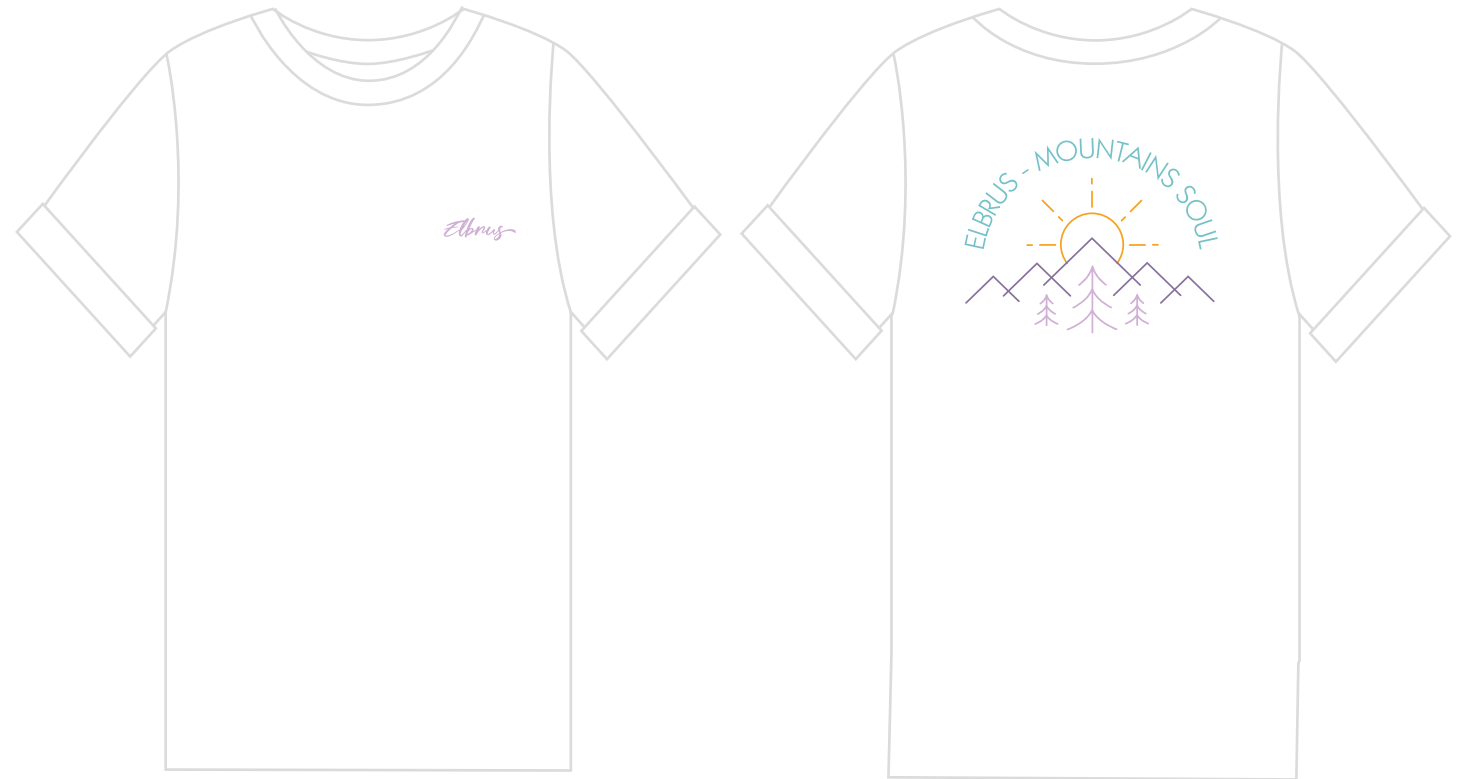

WHITE



PINK PEACOCK

INGER WO'S HOODIE

SIZE: XS-XL

MATERIAL COMPOSITION:
100% ORGANIC COTTON ,175 g/m²

NEW PRODUCT



ORCHID MIST



NARICA WO'S HOODIE

SIZE: XS-XL

MATERIAL COMPOSITION:
95% ORGANIC COTTON, 5% ELASTANE, 190 g/m²

NEW PRODUCT



SKIPPER BLUE



WHITE

SOGIA WO'S PANTS

SIZE: XS-XL

MATERIAL COMPOSITION:
60% COTTON, 40% POLYESTER, 280g/m2

SPECIFICATION:
- MICROFLEECE LINED



MIDNIGHT NAVY/BRIDAL ROSE

KIRRA WO'S PANTS

SIZE: XS-XL

MATERIAL COMPOSITION:
60% COTTON, 40% POLYESTER, 280g/m2

SPECIFICATION:
- MICROFLEECE LINED

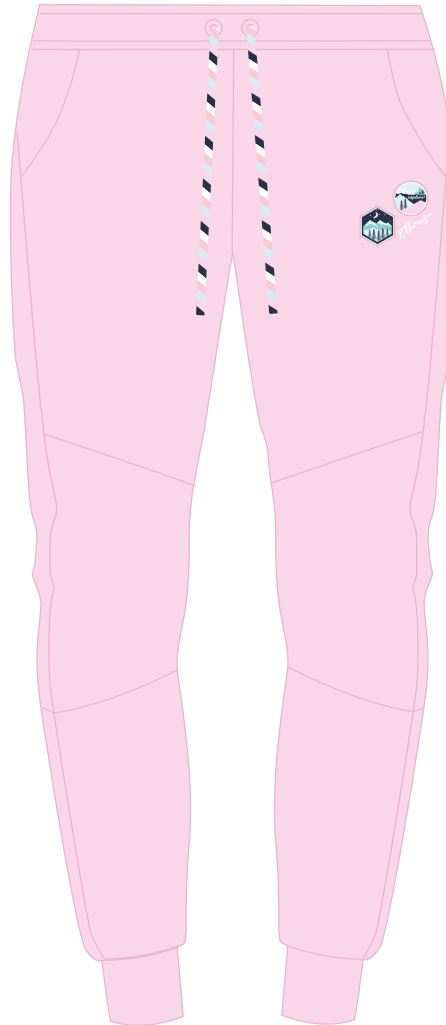

CHERRY BLOSSOM



TOTAL ECLIPSE

RAKINA WO'S PANTS

SIZE: XS-XL

MATERIAL COMPOSITION:
60% COTTON, 40% POLYESTER, 300 g/m²



SKIPPER BLUE

NEW PRODUCT

ZINA WO'S PANTS

SIZE: XS-XL

MATERIAL COMPOSITION:
60% COTTON, 40% POLYESTER, 300 g/m²

NEW PRODUCT



ORCHID MIST

JUNIORS'S COTTON SPRING/SUMMER 2023



 **RAFNE TB** BLOUSE

SIZE: 152-164

MATERIAL COMPOSITION:
60% COTTON, 40% POLYESTER, 300g/m2

SPECIFICATION:
- MICROFLEECE LINED



CADMIUM YELLOW/TOTAL ECLIPCE



REGIN TB PANTS

SIZE: 152-164

MATERIAL COMPOSITION:
60% COTTON, 40% POLYESTER, 300g/m2

SPECIFICATION:
- MICROFLEECE LINED



CADMIUM YELLOW/TOTAL ECLIPCE

NAPO III TB T-SHIRT

SIZE: 152-164

MATERIAL COMPOSITION:
100% COTTON, 160g/m2

SPECIFICATION:
- ORGANIC COTTON



JUNE BUG



ESKIL TB T-SHIRT

SIZE: 152-164

MATERIAL COMPOSITION:
100% COTTON, 160g/m2

SPECIFICATION:
- ORGANIC COTTON



CADMIUM YELLOW



PIKER TB T-SHIRT

SIZE: 152-164

MATERIAL COMPOSITION:
100% COTTON, 160g/m2

SPECIFICATION:
- ORGANIC COTTON

NEW PRODUCT



CHINESE RED



BLACK



 **ARIUS TB** T-SHIRT

SIZE:152-164

MATERIAL COMPOSITION:
100% COTTON, 160 g/m²



CITRONELLE

NEW PRODUCT

 **MIKEL TB** SHORTS

SIZE: 152-164

MATERIAL COMPOSITION:

MATERIAL COMPOSITION: 60% COTTON, 40%
POLYESTER, 300 g/m²



BLACK

NEW PRODUCT

 **RAGNA TG** SWEATSHIRT

SIZE: 152-164

MATERIAL COMPOSITION:
60% COTTON, 40% POLYESTER, 300g/m2

SPECIFICATION:
- MICROFLEECE LINED



CRYSTAL ROSE/PINK PANTHER



RIKKA TG SWEATPANTS

SIZE: 152-164

MATERIAL COMPOSITION:
60% COTTON, 40% POLYESTER, 300g/m2

SPECIFICATION:
- MICROFLEECE LINED

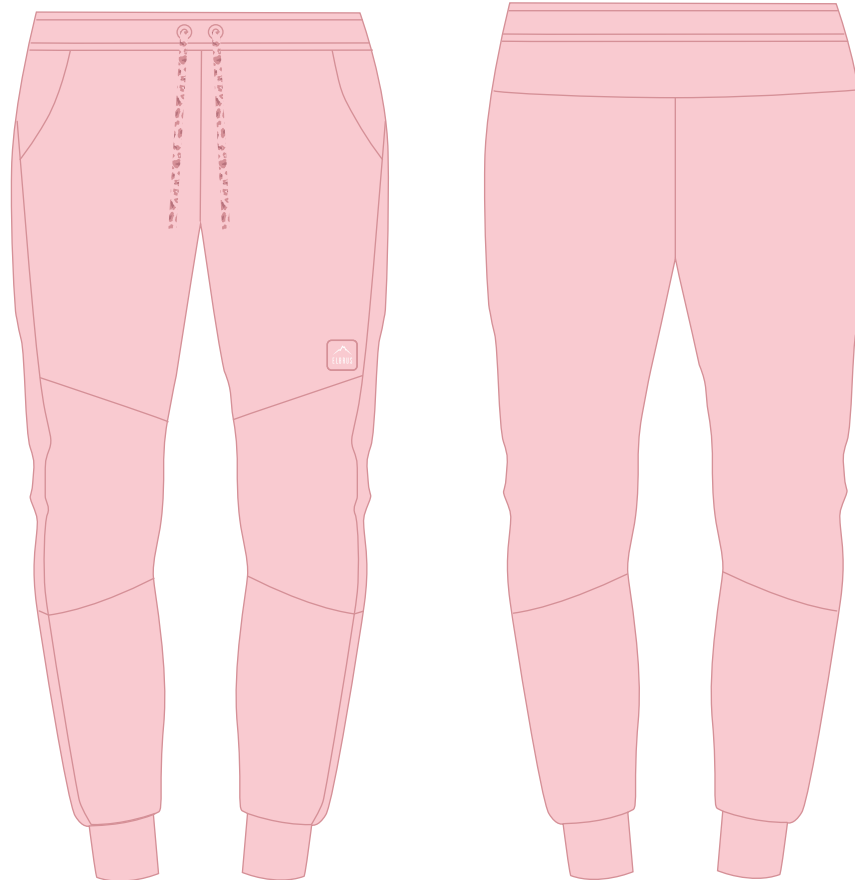

CRYSTAL ROSE



 **ZINA TG** SWEATPANTS

SIZE: 152-164

MATERIAL COMPOSITION: 60% COTTON, 40%
POLYESTER, 300 g/m²

NEW PRODUCT



TURQUOISE

 **TOVE JRG** BLOUSE

SIZE: 152-164

MATERIAL COMPOSITION: 100% COTTON,
160 g/m²



MARITIME BLUE



NEW PRODUCT

KARIT TG T-SHIRT

SIZE: 152-164

MATERIAL COMPOSITION: 100% COTTON,
160 g/m²

NEW PRODUCT



PINK PEACOCK



WHITE

LONELA TG BLOUSE

SIZE: 152-164

MATERIAL COMPOSITION:
100% COTTON, 160g/m2

SPECIFICATION:
- ORGANIC COTTON



DEEP LAKE



MEN'S ACTIVE SPRING/SUMMER 2023



 **MAMORE** SWEATSHIRT

SIZE: M-XXL

MATERIAL COMPOSITION:
97% POLYESTER, 3% ELASTANE



BLACK/FLAME SCARLET



SIZE: M-XXL

MATERIAL:
FLEECE: 100% POLYESTER, 190 g/m²



FLAME SCARLET/SALSA



 **ALMAR** LONG SLEEVE

SIZE: S-XXL

MATERIAL COMPOSITION:
100% POLYESTER



SALSA



BLACK

OLIO T-SHIRT

SIZE: S-XXL

MATERIAL COMPOSITION:

SHELL 1: 92% POLYESTER, 8% SPANDEX, 170 g/m²

SHELL 2: 92% POLYESTER, 8% SPANDEX, 155 g/m²

SPECIFICATION:

- QUICK DRY



DARK FOREST



NEW PRODUCT

JARI T-SHIRT

SIZE: S-XXL

MATERIAL COMPOSITION: 88% POLYESTER,
12% SPANDEX, 145 g/m²

SPECIFICATION:
- QUICK DRY

NEW PRODUCT



CITRONELLE



DEEP TEAL



BLACK



SMOKE PINE/CITRONELLE

NEW PRODUCT

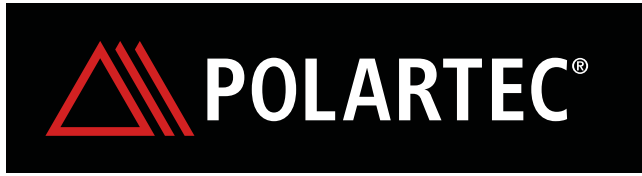

SIZE: M-XXL

MATERIAL:



SALSA



BLACK



 **ROAM** SWEAT PANTS

SIZE: M-XXL

MATERIAL COMPOSITION:
97% POLYESTER, 3% ELASTANE



LIGHT GREY MELANGE

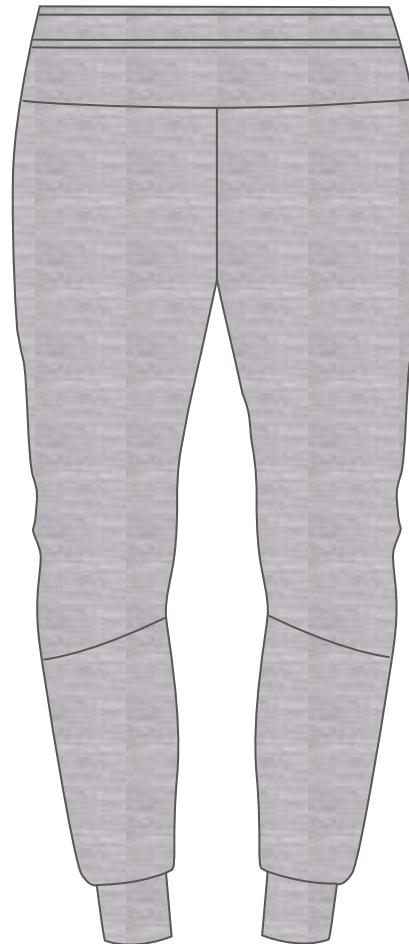

BLACK/FLAME SCARLET

PARU SHORTS

SIZE: M-XXL

MATERIAL COMPOSITION:
95% POLYAMIDE, 5% ELASTANE

SPECIFICATION:

- ULTRALIGHT
- AIRWAY
- QUICKDRY
- BACK POCKET

NEW PRODUCT



URBAN CHICK



CABIO SHORTS

SIZE: S-XXL

MATERIAL COMPOSITION:
85% NYLON, 15% ELASATNE

SPECIFICATION:

- ULTRALIGHT
- AIRWAY
- QUICKDRY



CITRONELLE

WOMEN'S ACTIVE SPRING/SUMMER 2023



 **CAURA WO'S** HOODIE

SIZE: S-XL

MATERIAL COMPOSITION:
75% NYLON, 25% ELASTANE



BLACK

MOLIC POLARTEC WO'S POLARTEC® POWER DRY



SIZE: S-L

MATERIAL COMPOSITION:

SPECIFICATION:

-



TOTAL ECLIPSE/CHERRY BLOSSOM



CARMA WO'S LONGSLEEVE

SIZE: XS-XL

MATERIAL COMPOSITION:

SHELL 1: 92% POLYESTER, 8% ELASTANE SHELL

2: 86%NYLON, 14% ELASTANE

230 g/m2

CERTIFICATES: OEKO-TEX®



ELDERBERRY



 **ALMAR WO'S** LONG SLEEVE

SIZE: S-L

MATERIAL COMPOSITION:

SPECIFICATION:

-



FLAMINGO PINK

 **ARVI WO'S** T-SHIRT

SIZE: S-L

MATERIAL COMPOSITION:

SPECIFICATION:

-

NEW PRODUCT



CHERRY BLOSSOM



JARI WO'S T-SHIRT

SIZE: XS-XL

MATERIAL COMPOSITION:
91% POLYESTER, 9% SPANDEX

SPECIFICATION:

- AIRWAY
- QUICKDRY
- ULTRALIGHT
- COOL DRY TECHNOLOGY

NEW PRODUCT



CHERRY BLOSSOM



BLUE SURF

CANGA WO'S PANTS

SIZE: XS-XL

MATERIAL COMPOSITION:

SHELL 1: 92% POLYESTER, 8% ELASTANE SHELL

2: 86% NYLON, 14% ELASTANE

230 g/m²

CERTIFICATES: OEKO-TEX®

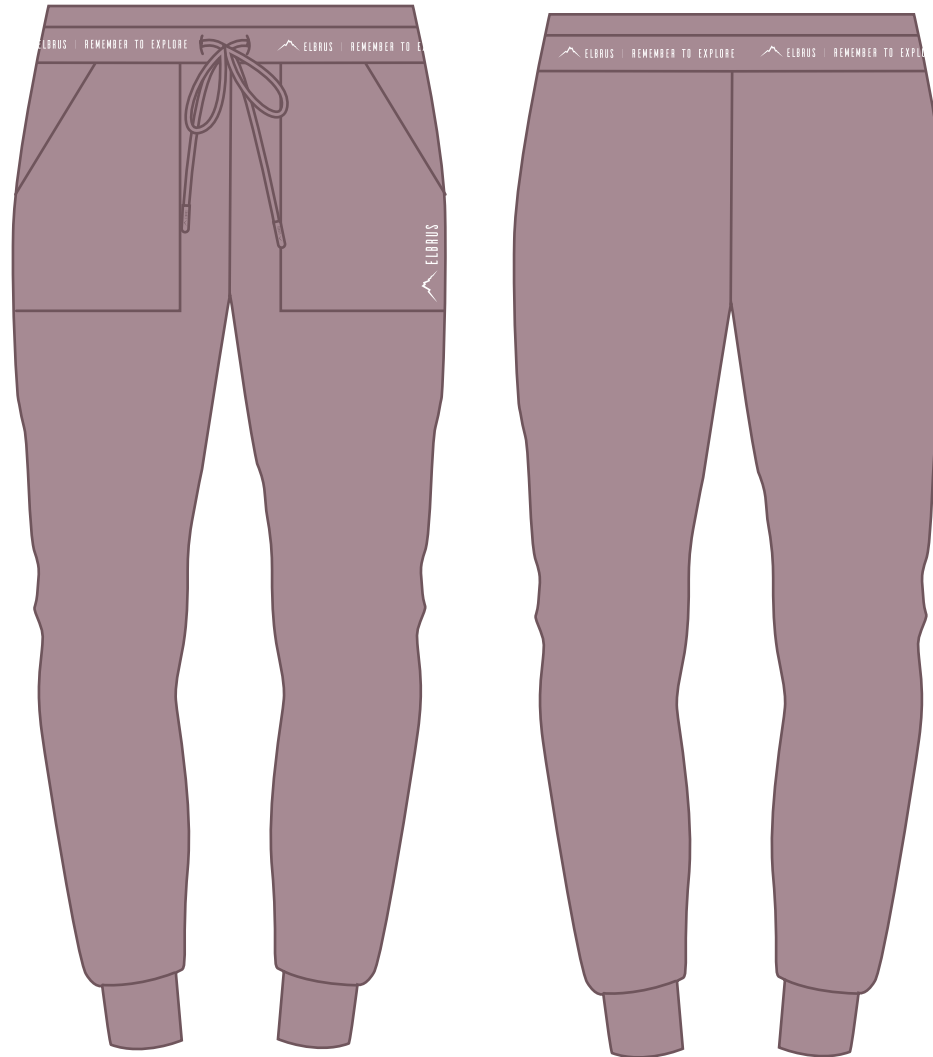

ELDERBERRY

MARA WO'S HOODIE

SIZE: XS-XL

MATERIAL COMPOSITION:
80% POLYESTER, 20% SPANDEX

SPECIFICATION:
- QUICKDRY
- INNER POCKET
- COOL DRY TECHNOLOGY

NEW PRODUCT

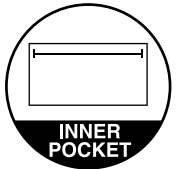

BLACK PLUM/ELDERBERRY

NORTH ATLANTIC/BLUE SURF

PARU WO'S SHORTS

SIZE: XS-XL

MATERIAL COMPOSITION: 92% POLYESTER, 8% ELASTANE

SPECIFICATION:

- ULTRALIGHT
- AIRWAY
- QUICKDRY
- BACK POCKET
- BUILT- IN- BRIEFS

NEW PRODUCT



BLACK PLUM

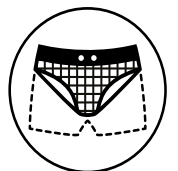
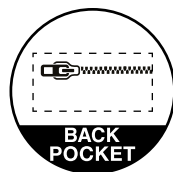

ORCHID MIST

JUNIOR'S ACTIVE SPRING/SUMMER 2023



 **PARU TB** LONGSLEEVE

SIZE: 152-164

MATERIAL COMPOSITION:
95% POLYAMIDE, 5% ELASTANE



CADMIUM YELLOW



 **PARU TG** SHORTS

SIZE: 152-164

MATERIAL COMPOSITION:
95% POLYAMIDE, 5% ELASTANE



BLUE SLATE

 **NANNA TG** LEGGINGS

SIZE: 152-164

MATERIAL COMPOSITION:
80% POLYESTER, 20% SPANDEX



JUNGLE PRINT

ACCESSORIES SPRING/SUMMER 2023



ALMEN CAP

SIZE: ONE SIZE

MATERIAL COMPOSITION:
100% NYLON

SPECIFICATION:
- AIR WAY
- QUICKDRY

NEW PRODUCT

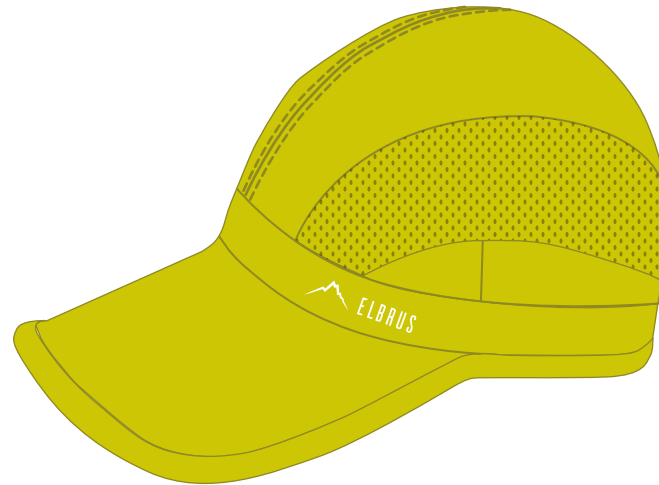

CITRONELLE



DEEP TEAL



DRESS BLUES

 **ETHAN** CAP

SIZE: ONE SIZE

MATERIAL COMPOSITION:
100% COTTON



KEY LARGO/BRITTANY BLUE



FLAME SCARLET/SALSA

 **RAMOND** CAP

SIZE: ONE SIZE

MATERIAL COMPOSITION:
70% COTTON, 30% POLYESTER

NEW PRODUCT



CITRONELLE/WOODBINE



FLAME SCARLET/CHILI PEPPER



DRESS BLUES / BLUE MOUNTAINS PRINT

NIVELLE HAT

SIZE: ONE SIZE

MATERIAL COMPOSITION:
100% NYLON

NEW PRODUCT

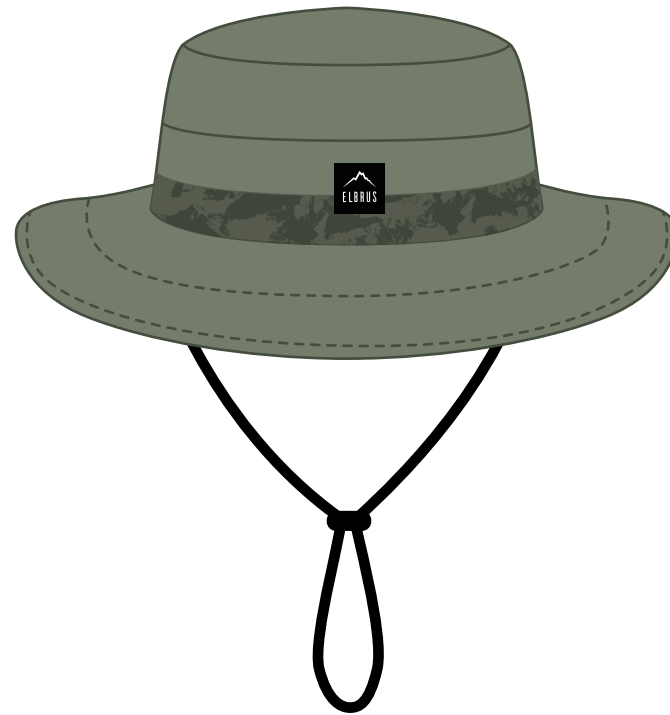

SEA SPRAY/THYME PRINT



BEIGE/OLIVINE PRINT

NIKO HAT

SIZE: ONE SIZE

MATERIAL COMPOSITION:
SHELL: 95% POLYESTER, 5%ELASTANE
LINING: 100% POLYESTER

SPECIFICATION:
- REFLECTIVE ELEMENTS



BLACK



YELLOW GREEN MAP



RIOKO HEADBAND

SIZE: ONE SIZE

MATERIAL COMPOSITION:

SHELL: 95% POLYESTER, 5%ELASTANE

LINING: 100% POLYESTER

SPECIFICATION:

- REFLECTIVE ELEMENTS

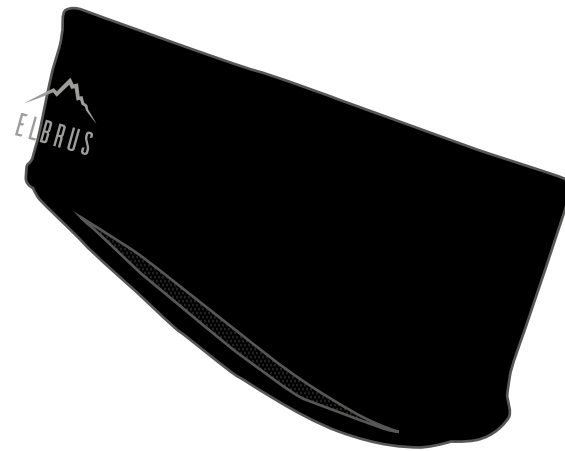

BLACK



 **NORIKO** NECK WARMER

SIZE: ONE SIZE

MATERIAL COMPOSITION:
SHELL: 95% POLYESTER, 5% ELASTANE
LINING: 100% POLYESTER



BLACK



YELLOW GREEN MAP

LANDECK HEADBAND

SIZE: ONE SIZE

MATERIAL COMPOSITION:
65% POLYESTER, 28% POLYAMIDE,
7% ELASTANE

SPECIFICATION:

- AIR WAY
- QUICKDRY
- SEAMLESS

NEW PRODUCT



BLACK/STRETCH LIMO



DIRECTORIE BLUE/DRESS BLUES



CITRONELLE / WOODBINE



ALMEN WO`S CAP

SIZE: ONE SIZE

MATERIAL COMPOSITION:
100% NYLON

SPECIFICATION:
- AIR WAY
- QUICKDRY



BLACK PLUM



TUWA WO'S CAP

SIZE: ONE SIZE

MATERIAL COMPOSITION:
100% COTTON

NEW PRODUCT



CHERRY BLOSSOM



ORCHID MIST



ASH ROSE

PIRENE WO`S CAP

SIZE: ONE SIZE

MATERIAL COMPOSITION:
100% POLYESTER



SKIPPER BLUE / VIOLET MOUNTAINS PRINT



TURQUOISE PRINT/TOTAL ECLIPSE

NEW PRODUCT

NIKO WO'S HAT

SIZE: ONE SIZE

MATERIAL COMPOSITION:
SHELL: 95% POLYESTER, 5%ELASTANE
LINING: 100% POLYESTER

SPECIFICATION:
- REFLECTIVE ELEMENTS

NEW PRODUCT

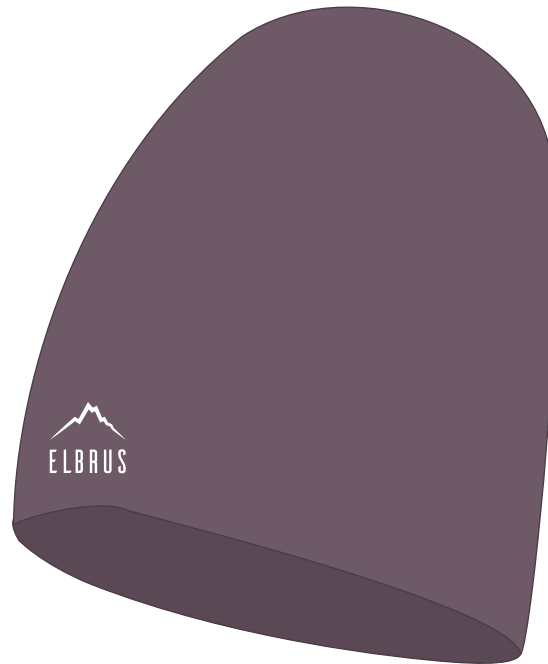

BLACK PLUM



PASTEL JUNGLE PRINT



RIOKO WO'S HEADBAND

SIZE: ONE SIZE

MATERIAL COMPOSITION:

SHELL: 95% POLYESTER, 5%ELASTANE

LINING: 100% POLYESTER

SPECIFICATION:

- REFLECTIVE ELEMENTS

NEW PRODUCT

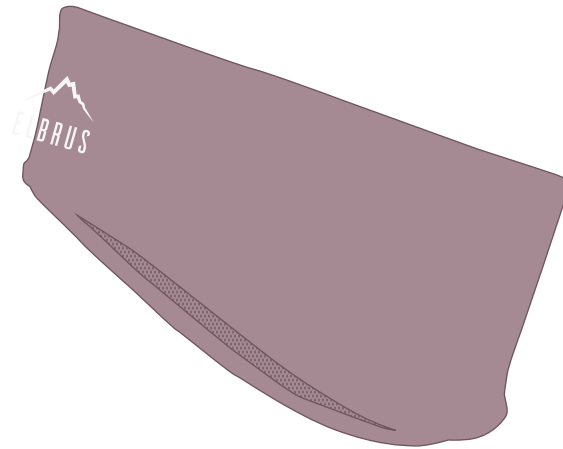

ELDERBERRY



PASTEL JUNGLE PRINT



NORIKO WO`S NECK WARMER

SIZE: ONE SIZE

MATERIAL COMPOSITION:
SHELL: 95% POLYESTER, 5%ELASTANE
LINING: 100% POLYESTER

NEW PRODUCT



PASTEL JUNGLE PRINT

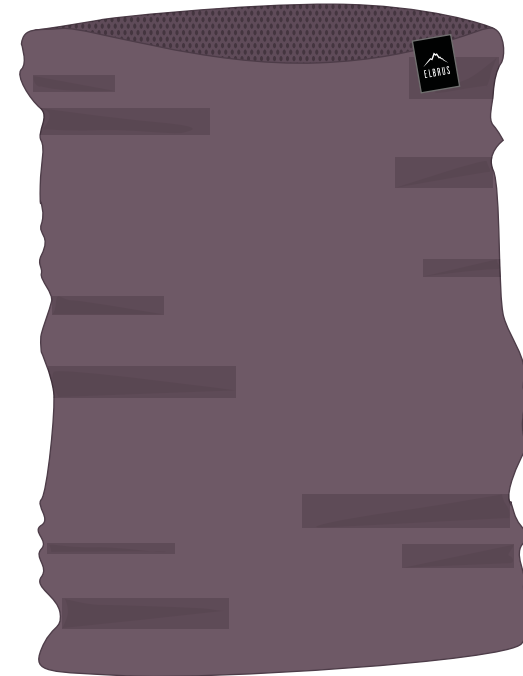

BLACK PLUM

LANDECK WO`S HEADBAND

SIZE: ONE SIZE

MATERIAL COMPOSITION:
65% POLYESTER, 28% POLYAMIDE,
7% ELASTANE

SPECIFICATION:

- AIR WAY
- QUICKDRY
- SEAMLESS

NEW PRODUCT



ELDERBERRY/BLACK PLUM



 **LEOZ JRB** CAP

SIZE: ONE SIZE

MATERIAL COMPOSITION:
70% COTTON, 30% POLYESTER

NEW PRODUCT



TOTAL ECLIPCE/CADMIUM YELLOW

 **LEOZ JRG** CAP

SIZE: ONE SIZE

MATERIAL COMPOSITION:
70% COTTON, 30% POLYESTER



CRYSTAL ROSE

 **NIKO TB** CAP

SIZE: ONE SIZE

MATERIAL COMPOSITION: 95% POLYESTER,
5% ELASTANE
LINING: 100% POLYESTER

NEW PRODUCT

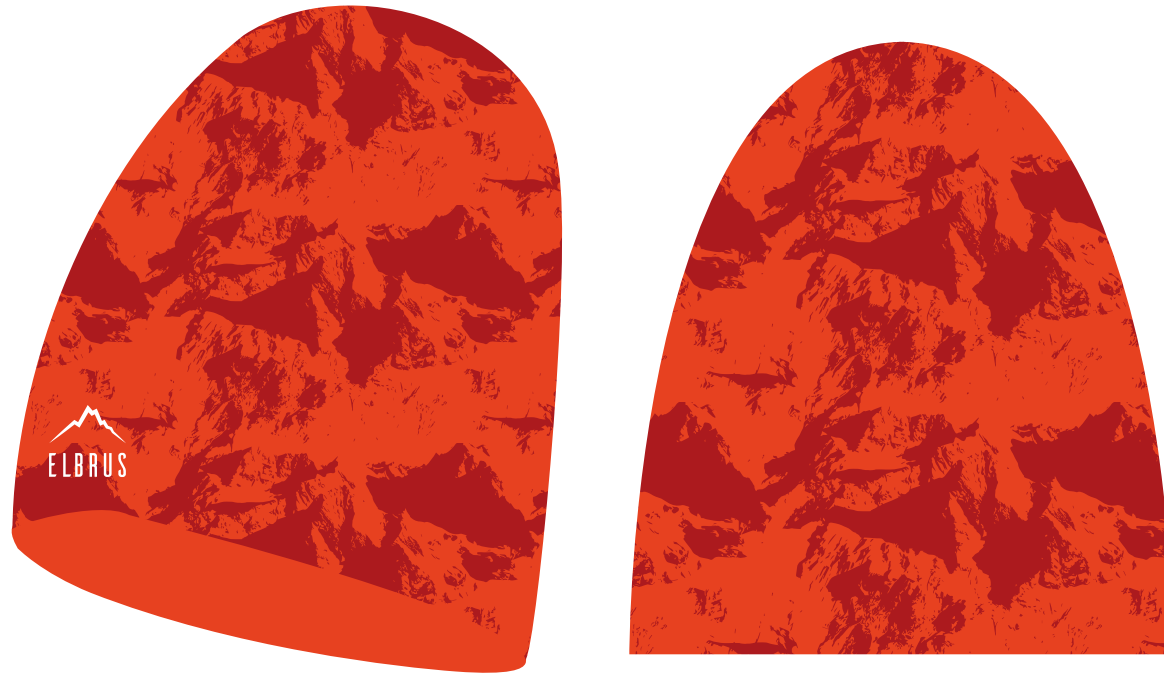

ORANGE MOUNTAINS PRINT

 **NIKO TG** CAP

SIZE: ONE SIZE

MATERIAL COMPOSITION: 95% POLYESTER,
5% ELASTANE
LINING: 100% POLYESTER

NEW PRODUCT



JUNGLE PRINT

 **NORIKO TG** CAP

SIZE: ONE SIZE

MATERIAL COMPOSITION:
SHELL: 95% POLYESTER, 5%ELASTANE
LINNING: 100% POLYESTER



ORANGE MOUNTAINS PRINT

NEW PRODUCT

 **NORIKO TG** CAP

SIZE: ONE SIZE

MATERIAL COMPOSITION:
SHELL: 95% POLYESTER, 5%ELASTANE
LINNING: 100% POLYESTER



JUNGLE PRINT

NEW PRODUCT

SYLGJA BELT

SIZE: ONE SIZE

MATERIAL COMPOSITION:
STRAP: 100% POLYESTER
BUCKLE: PP

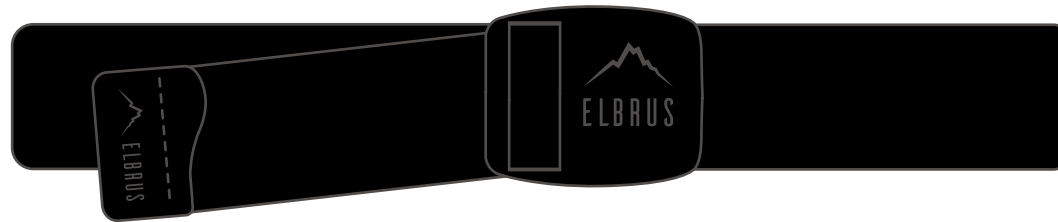

BLACK

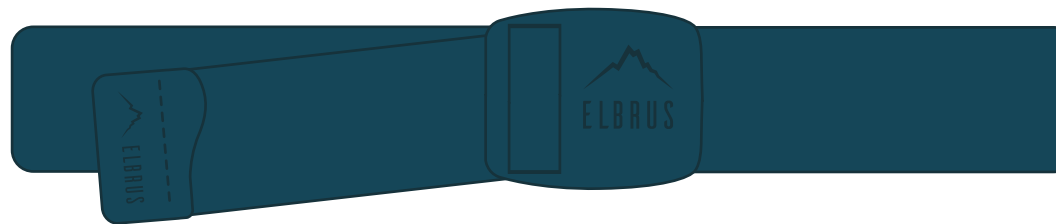

OCEAN DEPTHS

 **LYSE** BELT

SIZE: ONE SIZE

MATERIAL COMPOSITION:
STRAP: 30% ELASTANE, 70% POLYESTER
BUCKLE: 100% ZINC ALLOY

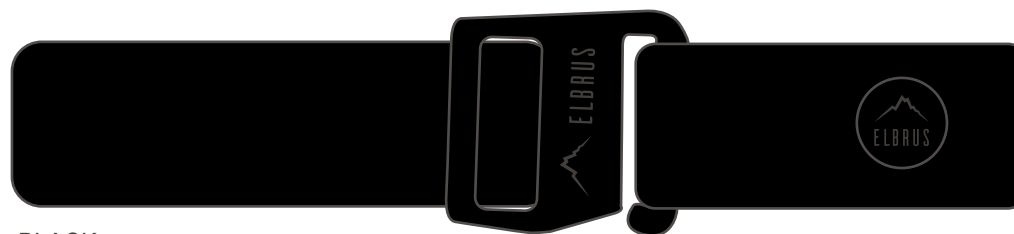

BLACK

VERDA POLARTEC HAT POLARTEC® 100 SERIES FLEECE



SIZE: ONE SIZE

MATERIAL COMPOSITION:
100% POLYESTER (MICROFLEECE)

SPECIFICATION:

- SOFT COMFORT
- WARMTH WITHOUT WEIGHT
- HIGHLY BREATHABLE
- DURABLE
- RECYCLED
- BLUESIGN
- OEKO-TEX



BLACK

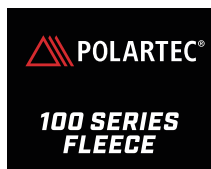

✕ VERDA POLARTEC WO`S HAT POLARTEC® 100 SERIES FLEECE



SIZE: ONE SIZE

MATERIAL COMPOSITION:
100% POLYESTER (MICROFLEECE)

SPECIFICATION:

- SOFT COMFORT
- WARMTH WITHOUT WEIGHT
- HIGHLY BREATHABLE
- DURABLE
- RECYCLED
- BLUESIGN
- OEKO-TEX



LAPIS



VALIER POLARTEC HEADBAND POLARTEC® 100 SERIES FLEECE



SIZE: ONE SIZE

MATERIAL COMPOSITION:
100% POLYESTER

- SPECIFICATION:
- SOFT COMFORT
 - WARMTH WITHOUT WEIGHT
 - HIGHLY BREATHABLE
 - DURABLE
 - RECYCLED
 - BLUESIGN
 - OEKO-TEX

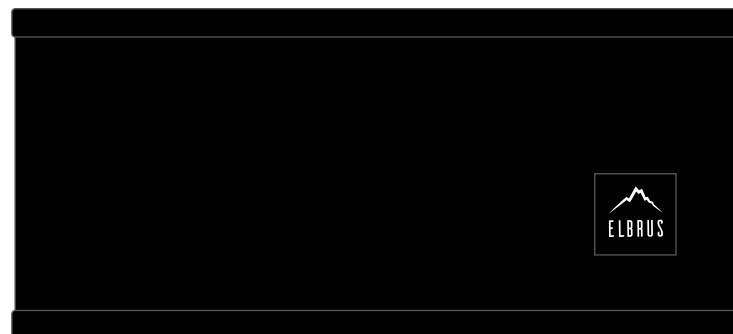

BLACK

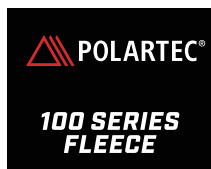

VIERO POLARTEC GLOVES POLARTEC® 100 SERIES FLEECE



SIZE: S/M, L/XL

MATERIAL COMPOSITION:
100% POLYESTER

SPECIFICATION:

- SOFT COMFORT
- WARMTH WITHOUT WEIGHT
- HIGHLY BREATHABLE
- DURABLE
- RECYCLED
- BLUESIGN
- OEKO-TEX



BLACK

✕ VIERO POLARTEC WO'S GLOVES POLARTEC® 100 SERIES FLEECE



SIZE: S/M, L/XL

MATERIAL COMPOSITION:
100% POLYESTER

- SPECIFICATION:
- SOFT COMFORT
 - WARMTH WITHOUT WEIGHT
 - HIGHLY BREATHABLE
 - DURABLE
 - RECYCLED
 - BLUESIGN
 - OEKO-TEX

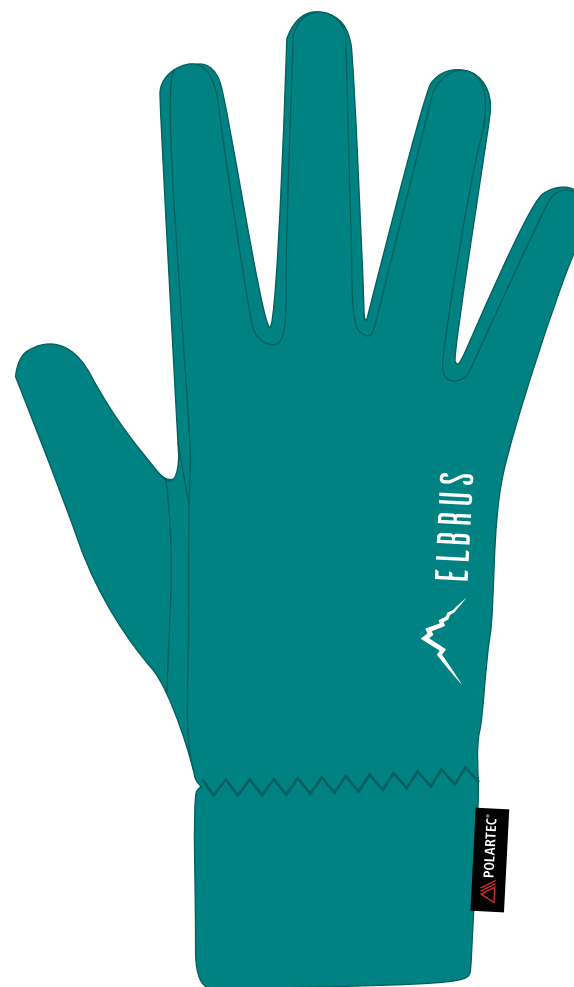
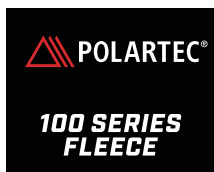

LAPIS

KADAR POLARTEC BALACLAVA POLARTEC® 100 SERIES FLEECE



SIZE: ONE SIZE

MATERIAL COMPOSITION:
100% POLYESTER

SPECIFICATION:

- SOFT COMFORT
- WARMTH WITHOUT WEIGHT
- HIGHLY BREATHABLE
- DURABLE
- RECYCLED
- BLUESIGN
- OEKO-TEX

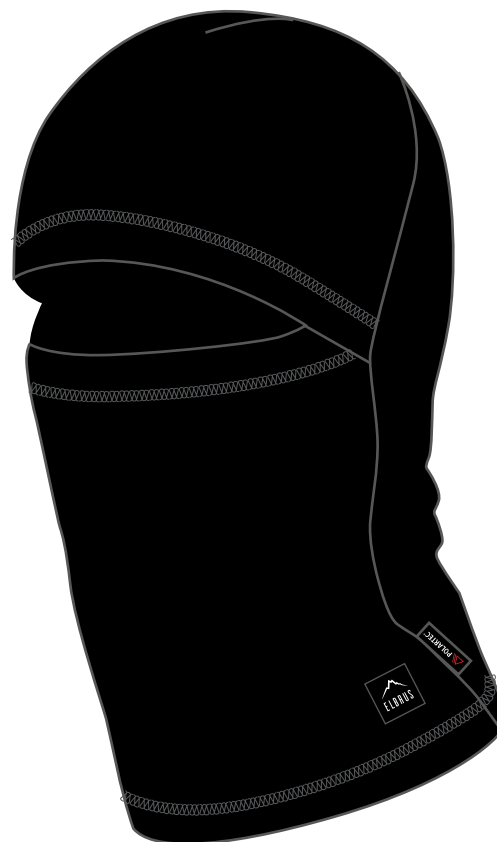

BLACK

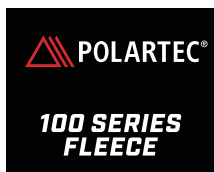

X KADAR POLARTEC WO'S BALACLAVA POLARTEC® 100 SERIES FLEECE



SIZE: ONE SIZE

MATERIAL COMPOSITION:
100% POLYESTER

- SPECIFICATION:
- SOFT COMFORT
 - WARMTH WITHOUT WEIGHT
 - HIGHLY BREATHABLE
 - DURABLE
 - RECYCLED
 - BLUESIGN
 - OEKO-TEX

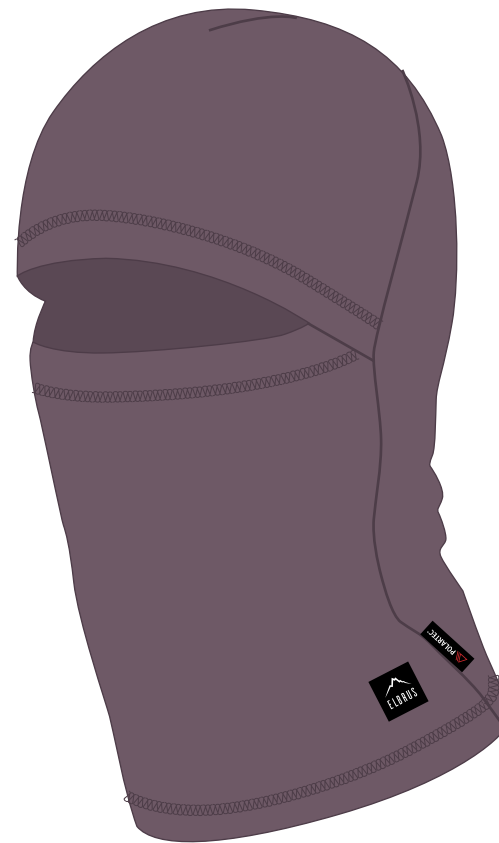

BLACK PLUM

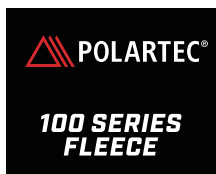

CARLIT POLARTEC NECK WARMER POLARTEC® 200 SERIES FLEECE



SIZE: ONE SIZE

MATERIAL COMPOSITION:
100% POLYESTER

SPECIFICATION:

- SOFT COMFORT
- WARMTH WITHOUT WEIGHT
- HIGHLY BREATHABLE
- DURABLE
- RECYCLED
- BLUESIGN
- OEKO-TEX



BLACK

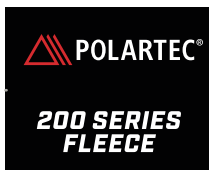

CARLIT POLARTEC WO`S NECK WARMER POLARTEC® 200 SERIES FLEECE



SIZE: ONE SIZE

MATERIAL COMPOSITION:
100% POLYESTER

- SPECIFICATION:
- SOFT COMFORT
 - WARMTH WITHOUT WEIGHT
 - HIGHLY BREATHABLE
 - DURABLE
 - RECYCLED
 - BLUESIGN
 - OEKO-TEX



ELDERBERRY

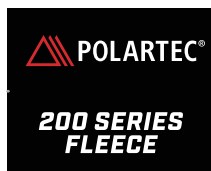

SIZE: UNISEX

MATERIAL COMPOSITION: 100% POLYESTER

SPECIFICATION:

- SOFT COMFORT
- WARMTH WITHOUT WEIGHT
- HIGHLY BREATHABLE
- DURABLE
- RECYCLED
- BLUESIGN
- OEKO-TEX



BLACK



TIROLO POLARTEC HEADBAND POLARTEC® WINDBLOCK



SIZE: ONE SIZE

MATERIAL COMPOSITION:
100% POLYESTER

SPECIFICATION:

- SOFT COMFORT
- WARMTH WITHOUT WEIGHT
- HIGHLY BREATHABLE
- DURABLE
- RECYCLED
- BLUESIGN
- OEKO-TEX



BLACK





SIZE: UNISEX

MATERIAL COMPOSITION: CAP 100% POLYESTER /
HEADBAND 100% POLYESTER

SPECIFICATION:

- WINDPROOF
- WATER REPELLENT
- RESILIENT STRETCH
- BREATHABLE
- HIGHLY DURABLE
- BLUESIGN
- OEKO-TEX



BLACK



 **KENDA** SOFTSHELL POLARTEC® WINDBLOC®



SIZE: UNISEX

MATERIAL COMPOSITION: 100% POLYESTER

SPECIFICATION:

- WINDPROOF
- WATER REPELLENT
- VERSATILE MEBRANE
- RESILIENT STRETCH
- BREATHABLE
- HIGHLY DURABLE
- BLUESIGN
- OEKO-TEX

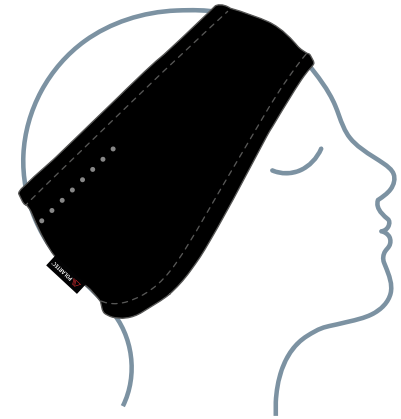

BLACK



TINIO POLARTEC GLOVES POLARTEC® WIND BLOCK



SIZE: S/M, L/XL

MATERIAL COMPOSITION:
100% POLYESTER

SPECIFICATION:

- WINDPROOF
- WATER REPELLENT
- VERSATILE MEBRANE
- RESILIENT STRETCH
- BREATHABLE
- HIGHLY DURABLE
- BLUESIGN
- OEKO-TEX



BLACK

X TINIO POLARTEC WO`S GLOVES POLARTEC® WIND BLOCK



SIZE: S/M, L/XL

MATERIAL COMPOSITION:
100% POLYESTER

SPECIFICATION:

- WINDPROOF
- WATER REPELLENT
- VERSATILE MEBRANE
- RESILIENT STRETCH
- BREATHABLE
- HIGHLY DURABLE
- BLUESIGN
- OEKO-TEX



BLACK

KEREM POLARTEC BALACLAVA POLARTEC® POWER STRETCH PRO



SIZE: ONE SIZE

MATERIAL COMPOSITION:
31% NYLON, 52% POLYESTER,
17% ELASTANE

- SPECIFICATION:
- DUAL-SURFACE
 - 4 WAY STRETCH
 - SUPERIOR ABRASION RESISTANCE
 - SHAPE RETENTION
 - HIGHLY BREATHABLE
 - WICKS MOISTURE
 - MICROFLEECE LINED
 - BLUESIGN
 - OEKO-TEX



BLACK



RHUNE POLARTEC BALACLAVA POLARTEC® WINDBLOCK

SIZE: ONE SIZE

MATERIAL COMPOSITION:

31% NYLON, 52% POLYESTER, 17% ELASTANE

SPECIFICATION:

- WINDPROOF
- WATER REPELLENT
- VERSATILE MEBRANE
- RESILIENT STRETCH
- BREATHABLE
- HIGHLY DURABLE
- DUAL-SURFACE
- 4 WAY STRETCH
- SUPERIOR ABRASION RESISTANCE
- SHAPE RETENTION
- HIGHLY BREATHABLE
- WICKS MOISTURE
- MICROFLEECE LINED
- BLUESIGN
- OEKO-TEX

 **POLARTEC**®

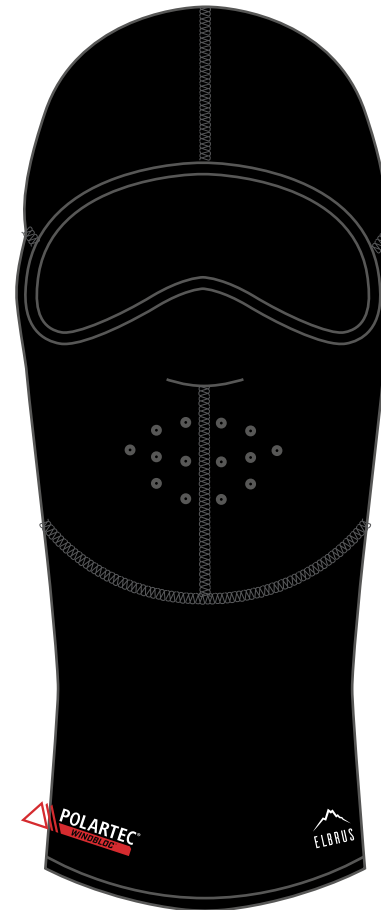

HIBISCUS

✕ PORTE POLARTEC GLOVES POLARTEC® POWER STRETCH PRO



SIZE: ONE SIZE

MATERIAL COMPOSITION:

31% NYLON, 52% POLYESTER, 17% ELASTANE

SPECIFICATION:

- DUAL-SURFACE
- 4 WAY STRETCH
- SUPERIOR ABRASION RESISTANCE
- SHAPE RETENTION
- HIGHLY BREATHABLE
- WICKS MOISTURE
- MICROFLEECE LINED
- BLUESIGN
- OEKO-TEX



BLACK

✕ PORTE POLARTEC WOS GLOVES POLARTEC® POWER STRETCH PRO



SIZE: ONE SIZE

MATERIAL COMPOSITION:

31% NYLON, 52% POLYESTER, 17% ELASTANE

SPECIFICATION:

- DUAL-SURFACE
- 4 WAY STRETCH
- SUPERIOR ABRASION RESISTANCE
- SHAPE RETENTION
- HIGHLY BREATHABLE
- WICKS MOISTURE
- MICROFLEECE LINED
- BLUESIGN
- OEKO-TEX



BLACK

BERRI POLARTEC NECK WARMER PPOLARTEC® 100 SERIES FLEECE



SIZE: ONE SIZE

MATERIAL COMPOSITION:
100% POLYESTER

SPECIFICATION:

- SOFT COMFORT
- WARMTH WITHOUT WEIGHT
- HIGHLY BREATHABLE
- DURABLE
- RECYCLED
- BLUESIGN
- OEKO-TEX



 **POLARTEC®**

**100 SERIES
FLEECE**



OEKO-TEX®
CONFIDENCE IN TEXTILES
STANDARD 100
1W 00004 1W

Zbadane na substancje szkodliwe.
www.oeko-tex.com/standard100



KEY LARGO/TOTAL ECLIPSE



FLAME SCARLET/CHILI PEPPER

BERRI POLARTEC WO'S NECK WARMER PPOLARTEC® 100 SERIES FLEECE



SIZE: ONE SIZE

MATERIAL COMPOSITION:
100% POLYESTER

- SPECIFICATION:
- SOFT COMFORT
 - WARMTH WITHOUT WEIGHT
 - HIGHLY BREATHABLE
 - DURABLE
 - RECYCLED
 - BLUESIGN
 - OEKO-TEX

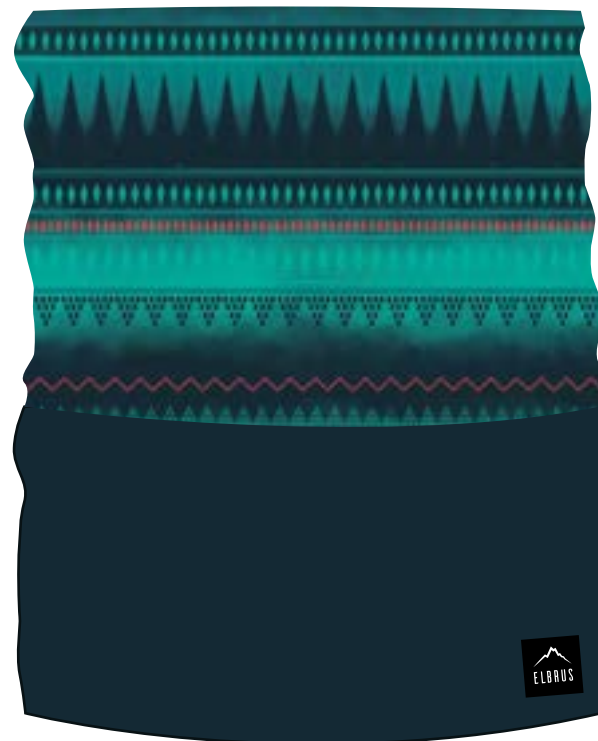
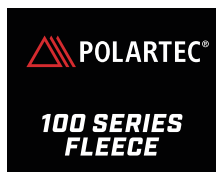

TURQUOISE PRINT/TOTAL ECLIPSE

FANDAR PROMALOFT^{SOCKS}



SIZE: 35-38, 39-42, 43-46

MATERIAL COMPOSITION:
POLYESTER (PRIMALOFT), POLYPROPYLENE,
POLYAMIDE, ELASTANE

SPECIFICATION:

- HIGH EXPANSIBILITY WELT
- COMFORT WEAR
- SHOCK ABSORBING SYSTEM
- STOP SYSTEM
- SMOOTH SEAMS



BLACK/GREY/RED

NEW PRODUCT

ELOF SOCKS

SIZE: 39-42, 43-46

MATERIAL COMPOSITION:
POLYESTER (DRYTEX), POLYAMIDE, ELASTANE

SPECIFICATION:
- HIGH EXPANSIBILITY WELT
- BREATH ZONE
- SHOCK ABSORBING SYSTEM
- STOP SYSTEM
- SMOOTH SEAMS



ACEITE / GRANAT

NEW PRODUCT

ELOF WO`S SOCKS

SIZE: SIZE: 35-38, 39-42

MATERIAL COMPOSITION:
POLYESTER (DRYTEX), POLYAMIDE, ELASTANE

SPECIFICATION:
- HIGH EXPANSIBILITY WELT
- BREATH ZONE
- SHOCK ABSORBING SYSTEM
- STOP SYSTEM
- SMOOTH SEAMS



MADUIXA / GRANAT

NEW PRODUCT

GORINE SOCKS

SIZE: 39-42, 43-46

MATERIAL COMPOSITION:

POLYESTER (DRYTEX), POLYPROPYLENE (POLY-COLON), POLYAMIDE, ELASTANE

SPECIFICATION:

- HIGH EXPANSIBILITY WELT
- COMFORT WEAR
- SHOCK ABSORBING SYSTEM
- STOP SYSTEM
- BREATH ZONE
- SMOOTH SEAMS



DRYTEX / LIMONKA

NEW PRODUCT

GORINE WO`S SOCKS

SIZE:

MATERIAL COMPOSITION:

POLYESTER (DRYTEX), POLYPROPYLENE (POLY-COLON), POLYAMIDE, ELASTANE

SPECIFICATION:

- HIGH EXPANSIBILITY WELT
- COMFORT WEAR
- SHOCK ABSORBING SYSTEM
- STOP SYSTEM
- BREATH ZONE
- SMOOTH SEAMS



ALPACA ANTRACIT / LIMONKA

NEW PRODUCT

IVARE SOCKS

SIZE: 39-42, 43-46

MATERIAL COMPOSITION:
MERINO WOOL, ALPACA WOOL, POLYAMIDE,
POLYPROPYLENE, ELASTANE

- SPECIFICATION:
- HIGH EXPANSIBILITY WELT
 - COMFORT WEAR
 - SHOCK ABSORBING SYSTEM
 - STOP SYSTEM
 - SMOOTH SEAMS



BASALT/LIME

NEW PRODUCT

IVARE WO`S SOCKS

SIZE: 35-38, 39-42

MATERIAL COMPOSITION:

MERINO WOOL, ALPACA WOOL, POLYAMIDE,
POLYPROPYLENE, ELASTANE

SPECIFICATION:

- HIGH EXPANSIBILITY WELT
- COMFORT WEAR
- SHOCK ABSORBING SYSTEM
- STOP SYSTEM
- SMOOTH SEAMS

NEW PRODUCT

SMOKE BLUE/ROSE

KIRTIM SOCKS

SIZE: 39-42

MATERIAL COMPOSITION:

50% MERINO WOOL, 40% COTTON, 7% POLYAMIDE, 3% ELASTANE

SPECIFICATION:

- BREATHABLE
- KEEPING THE HEAT
- ANTIBACTERIAL
- FAST DRYING



MARBLE MELE/NAVY/SAGE

NUMI SOCKS

SIZE: 39-42

MATERIAL COMPOSITION:

50% MERINO WOOL, 40% COTTON, 7% POLYAMIDE, 3% ELASTANE

SPECIFICATION:

- BREATHABLE
- KEEPING THE HEAT
- ANTIBACTERIAL
- FAST DRYING



NEW PRODUCT



NAVY/BEIGE/ORANGE

KIRTIM WO'S SOCKS

SIZE: 35-42

MATERIAL COMPOSITION:

50% MERINO WOOL, 40% COTTON, 7% POLYAMIDE, 3% ELASTANE

SPECIFICATION:

- BREATHABLE
- KEEPING THE HEAT
- ANTIBACTERIAL
- FAST DRYING



PINK/PRANGE PEEL/NATURWEISS

NUMI WO'S SOCKS

SIZE: 35-42

MATERIAL COMPOSITION:

50% MERINO WOOL, 40% COTTON, 7% POLYAMIDE, 3% ELASTANE

SPECIFICATION:

- BREATHABLE
- KEEPING THE HEAT
- ANTIBACTERIAL
- FAST DRYING

NEW PRODUCT



NAVY/PINK/BEIGE/ORANGE



 **MILIM** SOCKS

SIZE: 39-42, 43-46

MATERIAL COMPOSITION:
42% COTTON, 35% POLYESTER (DRYTEX), 9%
POLYPROPYLENE, 4% ELASTANE



CHILLI PEPPER/BLACK/TANGERINE TANGO

 **MILIM WO'S** SOCKS

SIZE: 35-38, 39-42

MATERIAL COMPOSITION:

42% COTTON, 35% POLYESTER (DRYTEX), 9%
POLYPROPYLENE, 4% ELASTANE



CHILLI PEPPER/BLACK/TANGERINE TANGO

 **TIPIN** SOCKS

SIZE: 39-42, 43-46

MATERIAL COMPOSITION:
45% POLYESTER (DRYTEX), 40% COTTON, 8%
POLYAMIDE, 7% ELASTANE

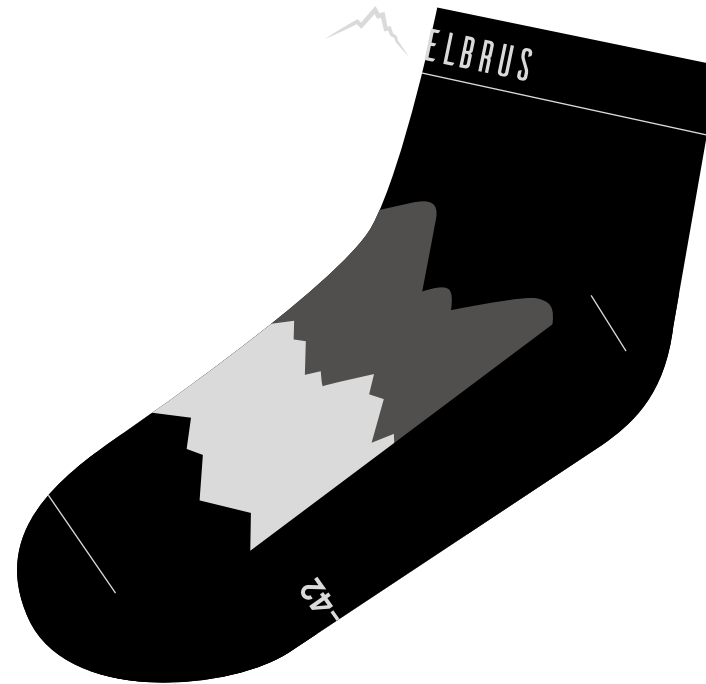

BLACK/GREY/WHITE

 **TIPIN WO'S** SOCKS

SIZE: 35-38, 39-42

MATERIAL COMPOSITION:
45% POLYESTER (DRYTEX), 40% COTTON, 8%
POLYAMIDE, 7% ELASTANE

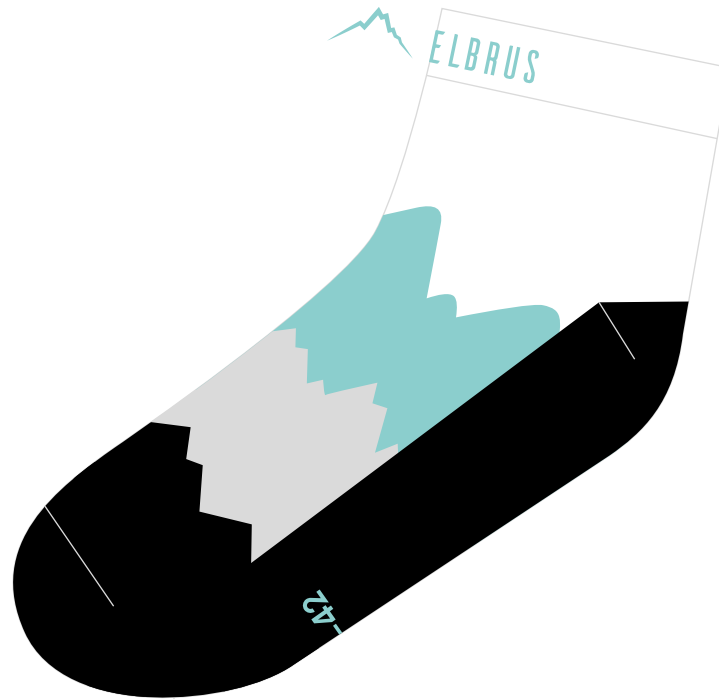

BLACK/WHITE/ARUBA BLUE

ELARIS PACK SOCKS

SIZES:

-

MATERIAL:

45% COTTON, 15% POLYPROPYLENE, 15%
POLYESTER, 15% POLYAMIDE, 10% ELASTANE



NAVY/BLUE

HAKAN JR SOCKS

SIZE: 28-32, 33-35

MATERIAL COMPOSITION:
ACRYLIC, MERINO WOOL, POLYAMIDE, ELASTANE

- SPECIFICATION:
- HIGH EXPANSIBILITY WELT
 - COMFORT WEAR
 - SHOCK ABSORBING SYSTEM
 - STOP SYSTEM
 - SMOOTH SEAMS



ACIAO / COBALT



ACIAO / AKRYL ROSA

NEW PRODUCT

 **YINE JR SOCKS**

SIZE: 28-32, 33-35, 36-38

MATERIAL COMPOSITION:
BAMBOO, POLYPROPYLENE, POLYAMIDE, ELASTANE

SPECIFICATION:
- BAMBO FIBER

NEW PRODUCT

GREY/BLACK/LIME

GREY/BLACK/PINK

SHOES SPRING/SUMMER 2023



 **ERAVICA LOW WP GR C** OUTDOOR SHOES

SIZE: 41-46

MATERIAL COMPOSITION:

NEW PRODUCT



GREEN GABLES/BLACK/ORANGE

TILBUR OUTDOOR SHOES

SIZE: 41-46

MATERIAL COMPOSITION:

UPPER: LEATHER, PU, RB RUBBER, TEXTILE

LINING: MESH

INSOLE: MESH, EVA FOAM

OUTSOLE: EVA FOAM, RB RUBBER



STEEL GREY / BLACK / LIME



NAMAL V OUTDOOR SHOES

SIZE: 41-46

MATERIAL COMPOSITION:

UPPER: SUEDE + PU + ACTION LEATHER + MESH

LINING: MESH

INSOLE: MESH, PU FOAM

OUTSOLE: EVA PHYLON, RB RUBBER

SPECIFICATION:

- VIBRAM

NEW PRODUCT



GREEN / CITRONELLE / BLACK

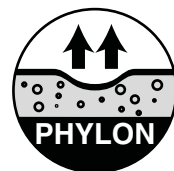

RAGLEY AG OUTDOOR SHOES

SIZE: 41-46

MATERIAL COMPOSITION:
UPPER: SOFTSHELL + TEXTILE + PU
LINING: MESH
INSOLE: MESH, EVA FOAM
OUTSOLE: RB RUBBER

SPECIFICATION:
- ACTIVGUARD

 **ActivGuard**



BLACK/GREY



BLACK/SALSA

NEW PRODUCT

RIMLEY WP OUTDOOR SHOES

SIZE: 41-46

MATERIAL COMPOSITION:

UPPER: SOFTSHELL, PU

LINING: MESH

INSOLE: MESH, EVA

OUTSOLE: RB RUBBER

SPECIFICATION:

- WATERPROOF MEMBRANE

NEW PRODUCT



BLACK / DARK GREY

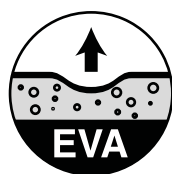

DRESS BLUE / FLAME SCARLET

MILKAR WP OUTDOOR SHOES

SIZE: 41-46

MATERIAL COMPOSITION:

UPPER: MESH

LINING: TEXTILE

INSOLE: MESH/PU FOAM (ORTHOLITE)

OUTSOLE: EVA PHYLON, RB RUBBER, TPU

SPECIFICATION:

- WATERPROOF MEMBRANE
- GOODYEAR
- ORTHOLITE INSOLE
- REFLECTIVE ELEMENTS



BLACK/CASTELROCK/FLAME SECRET

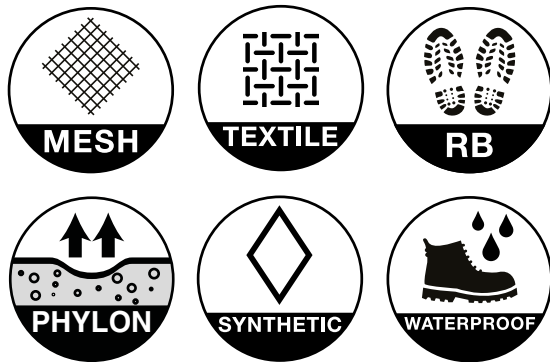

Ortholite®

GOODYEAR

WESKO WP OUTDOOR SHOES

SIZE: 41-46

MATERIAL COMPOSITION:

UPPER: 90%SOFTSHELL+10%TPU

LINING: MESH

INSOLE: MESH, EVA FOAM

OUTSOLE: EVA PHYLON,RB RUBBER,TPU

ADDITIONAL:

WATERPROOF MEMBRANE

REFLECTIVE ELEMENTS



BLACK



SOFTSHELL



SYNTHETIC

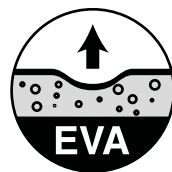

EVA



RB



WATERPROOF



MESH



REFLECTIVE

DONGO WP OUTDOOR SHOES

SIZE: 41-46

MATERIAL COMPOSITION:

UPPER: 85%TEXTILE+15%TPU

LINING: MESH

INSOLE: MESH, EVA FOAM

OUTSOLE: EVA PHYLON,RB RUBBER,

ADDITIONAL:

WATERPROOF MEMBRANE



BLACK/WHITE

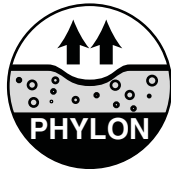
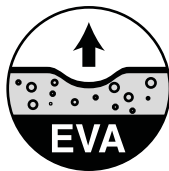

FAREN WP GR OUTDOOR SHOES

SIZE: 41-46

MATERIAL COMPOSITION:

UPPER: MESH + TPU

LINING: MESH

INSOLE: MESH, PU FOAM

OUTSOLE: EVA PHYLON, RB RUBBER, TPU

SPECIFICATION:

- HI-POLY INSOLE

- GOODYEAR

- WATERPROOF

NEW PRODUCT



OCEAN DEPTHS/BLACK/SAFFRON

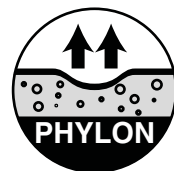

GOODYEAR

EUREN LOW WP V OUTDOOR SHOES

SIZE: 41-46

MATERIAL COMPOSITION:

UPPER: TEXTILE + PU

LINING: MESH

INSOLE: MESH, PU FOAM

OUTSOLE: EVA PHYLON, RB RUBBER, TPU

SPECIFICATION:

- ORTHOLITE INSOLE

- VIBRAM

- WATERPROOF

NEW PRODUCT



DRESS BLUES/TANGERINE TANGO



TEXTILE



SYNTHETIC



MESH

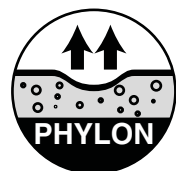

PHYLON



RB



WATER
PROOF

Ortholite®

EUBEREN LOW WP OUTDOOR SHOES

SIZE: 41-46

MATERIAL COMPOSITION:

UPPER: TEXTILE, PU

LINING: MESH

INSOLE: MESH, EVA FOAM

OUTSOLE: EVA PHYLON, RB RUBBER, TPU

SPECIFICATION:

- WATERPROOF MEMBRANE



DARK GREY/BLACK/LIME

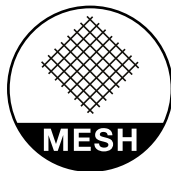
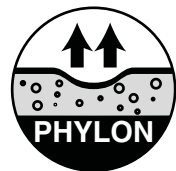

OMELIO WP GR OUTDOOR SHOES

SIZE: 41-46

MATERIAL COMPOSITION:

UPPER: TEXTILE + PU

LINING: MESH

INSOLE: MESH, PU FOAM

OUTSOLE: EVA PHYLON, RB RUBBER, TPU

SPECIFICATION:

- ORTHOLITE INSOLE

- GOODYEAR

- WATERPROOF

NEW PRODUCT



DRESS BLUES/DARK DENIM/TANGERINE TANGO



TEXTILE



SYNTHETIC

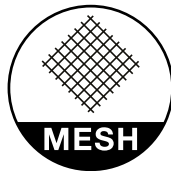

MESH

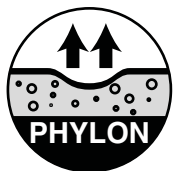

PHYLON



RB



WATER
PROOF

Ortholite®
GOODYEAR

EBRO WR GR OUTDOOR SHOES

SIZE: 41-46

MATERIAL COMPOSITION:

UPPER: TEXTILE, PU

LINING: MESH

INSOLE: MESH, PU FOAM

OUTSOLE: EVA PHYLON, RB RUBBER, TPU

SPECIFICATION:

- ORTHOLITE INSOLE
- GOODYEAR
- WATER RESISTANT
- REFLECTIVE ELEMENTS



ORANGE/DARK RED/WHITE/YELLOW

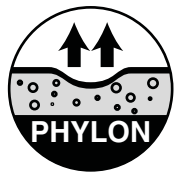

Ortholite®

GOODYEAR

ELMAR GR OUTDOOR SHOES

SIZE: 41-46

MATERIAL COMPOSITION:

UPPER: MESH

LINING: MESH

INSOLE: MESH, PU FOAM

OUTSOLE: EVA PHYLON, RB RUBBER, TPU

SPECIFICATION:

- ORTHOLITE INSOLE

- GOODYEAR



TILE BLUE/NAVY/RED

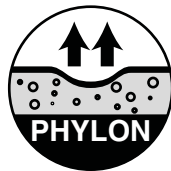

Ortholite®

GOODYEAR

ELTERO V WP OUTDOOR SHOES

SIZE: 41-46

MATERIAL COMPOSITION:

UPPER: MESH + TPU

LINING: MESH

INSOLE: MESH, PU FOAM

OUTSOLE: EVA PHYLON, RB RUBBER, TPU

SPECIFICATION:

- ORTHOLITE INSOLE

- VIBRAM

- WATERPROOF

NEW PRODUCT



DRESS BLUES/CLOSSONE/CITRONELLE

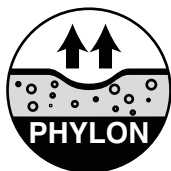

Ortholite®



ERGIDES WP OUTDOOR SHOES

NEW PRODUCT

SIZE: 41-46

MATERIAL COMPOSITION:

UPPER: MESH + PU

LINING: MESH

INSOLE: MESH, EVA FOAM

OUTSOLE: EVA PHYLON, RB RUBBER, TPU

SPECIFICATION:

- WATERPROOF



WOODBINE/CITRONELLE/BLACK

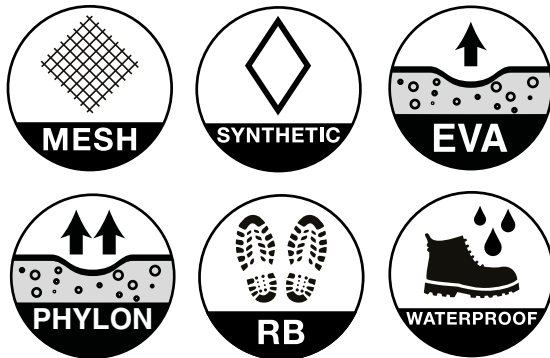

DUCK GREEN/DEEP DEPTHS/BLACK/BRIGHT MARIGOLD

 **DENOVA** OUTDOOR SHOES

SIZE: 41-46

MATERIAL COMPOSITION:

UPPER: MESH

LINING: MESH

INSOLE: MESH, EVA FOAM

OUTSOLE: RB RUBBER



BLACK / DARK GREY

NORUTA OUTDOOR SHOES

SIZE: 41-46

MATERIAL COMPOSITION:

UPPER: 95%MESH+5%TPU

LINING: MESH

INSOLE: MESH, EVA FOAM

OUTSOLE: EVA PHYLON, RB RUBBER

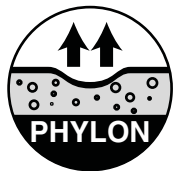
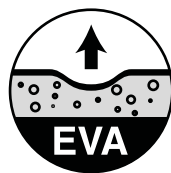

DRESS BLUES/CITRONELLE/BLACK

ELMISTI GR OUTDOOR SHOES

SIZE: 41-46

MATERIAL COMPOSITION:

UPPER: KNITTING

LINING: NON

INSOLE: MESH, PU FOAM

OUTSOLE: EVA PHYLON, RB RUBBER, TPU

SPECIFICATION:

- ORTHOLITE INSOLE

- GOODYEAR



DARK FORREST/CLIMBING IVY/SAFFRON



KNITTING



MESH



SYNTHETIC

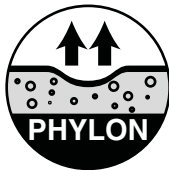

PHYLON



RB

Ortholite®

GOODYEAR

CALTER OUTDOOR SHOES

SIZE: 41-46

MATERIAL COMPOSITION:

UPPER: MESH + PU

LINING: MESH

INSOLE: MESH, EVA FOAM

OUTSOLE: EVA PHYLON, TPR RUBBER, TPU

NEW PRODUCT



BLACK/ORANGE/GREY

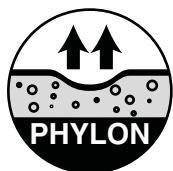

 **LOMERO** OUTDOOR SHOES

SIZE: 41-46

MATERIAL COMPOSITION:

NEW PRODUCT



GREY/BLACK/ORANGE

KENISER SANDALS

SIZE: 41-46

MATERIAL COMPOSITION

UPPER: WEBBING, PU

LINING: TEXTILE

OUTSOLE: EVA PHYLON, RB RUBBER:

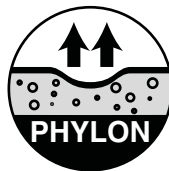

NAVY / BLACK / DARK RED

ECOLER SANDALS

SIZE: 41-46

MATERIAL COMPOSITION:

UPPER: PU, MESH

LINING: TEXTILE

INSOLE: TEXTILE, EVA FOAM

OUTSOLE: RB RUBBER



GREY/TURQUOISE



MERIOS SANDALS

SIZE: 41-46

MATERIAL COMPOSITION:

UPPER: PU

LINING: TEXTILE

OUTSOLE: EVA PHYLON, RB RUBBER

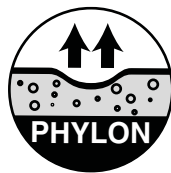

BLACK / FLAME

WIDERES SANDALS

SIZE: 41-46

MATERIAL COMPOSITION:

UPPER: PU, RB RUBBER

LINING: TEXTILE

OUTSOLE: EVA PHYLON, RB RUBBER

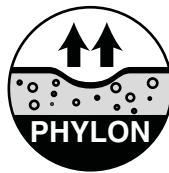

BLACK / BLACK

NAMAL V WO'S OUTDOOR SHOES

SIZE: 36-41

MATERIAL COMPOSITION:

UPPER: SUEDE + PU + ACTION LEATHER + MESH

LINING: MESH

INSOLE: MESH, PU FOAM

OUTSOLE: EVA PHYLON, RB RUBBER

SPECIFICATION:

- ORTHOLITE INSOLE

- VIBRAM

NEW PRODUCT



BLACK PLUM/BLACK

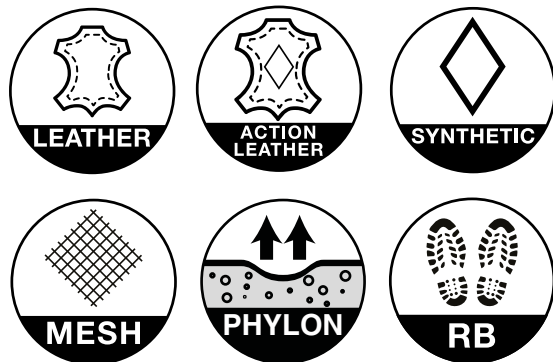

WESKO WP WO'S OUTDOOR SHOES

SIZE: 36-41

MATERIAL COMPOSITION:

UPPER: 90%SOFTSHELL+10%TPU

LINING: MESH

INSOLE: MESH, EVA FOAM

OUTSOLE: EVA PHYLON,RB RUBBER, TPU

ADDITIONAL:

WATERPROOF MEMBRANE

REFLECTIVE ELEMENTS



BLACK

FAREN WP GR WO'S OUTDOOR SHOES

SIZE: 36-41

MATERIAL COMPOSITION:

UPPER: MESH + TPU

LINING: MESH

INSOLE: MESH, PU FOAM

OUTSOLE: EVA PHYLON, RB RUBBER, TPU

SPECIFICATION:

- HI-POLY INSOLE

- GOODYEAR

- WATERPROOF



DARK ROSE/ASPHALT/PEACH AMBER

GOODYEAR

NEW PRODUCT

EUREN LOW WP V WO'S OUTDOOR SHOES

NEW PRODUCT

SIZE: 36-41

MATERIAL COMPOSITION:

UPPER: TEXTILE + PU

LINING: MESH

INSOLE: MESH, PU FOAM

OUTSOLE: EVA PHYLON, RB RUBBER, TPU

SPECIFICATION:

- ORTHOLITE INSOLE

- VIBRAM

- WATERPROOF



TEXTILE



SYNTHETIC

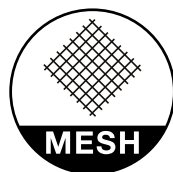

MESH

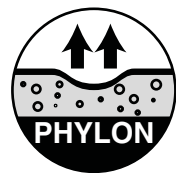

PHYLON



RB



SMOKE BLUE/BLACK/MINT



WATER
PROOF

Ortholite®

OMELIO WP GR WO'S OUTDOOR SHOES

NEW PRODUCT

SIZE: 36-41

MATERIAL COMPOSITION:

UPPER: TEXTILE + PU

LINING: MESH

INSOLE: MESH, PU FOAM

OUTSOLE: EVA PHYLON, RB RUBBER, TPU

SPECIFICATION:

- ORTHOLITE INSOLE

- GOODYEAR

- WATERPROOF



DRESS BLUES/BLUE BIRD



TEXTILE



SYNTHETIC



MESH



PHYLON



RB



WATER
PROOF

Ortholite®
GOODYEAR

ELTERO V WP WO'S OUTDOOR SHOES

SIZE: 36-41

MATERIAL COMPOSITION:

UPPER: MESH + TPU

LINING: MESH

INSOLE: MESH, PU FOAM

OUTSOLE: EVA PHYLON, RB RUBBER, TPU

SPECIFICATION:

- ORTHOLITE INSOLE

- VIBRAM

- WATERPROOF

NEW PRODUCT



BLUE BIRD/NAVY/HIBISCUS



Ortholite®



ERGIDES WP WO'S OUTDOOR SHOES

SIZE: 36-41

MATERIAL COMPOSITION:

UPPER: MESH,PU

LINING: MESH

INSOLE: MESH, EVA FOAM

OUTSOLE: EVA PHYLON, RB RUBBER, TPU

SPECIFICATION:

- WATERPROOF MEMBRANE
- REFLECTIVE ELEMENTS

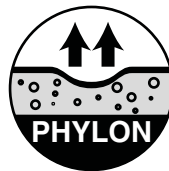

BALSAM GREEN/GREEN GABLES/CORAL ALMOND

ERIMLEY LOW WP WO'S OUTDOOR SHOES

SIZE: 36-41

MATERIAL COMPOSITION:

UPPER: 80%SOFTSHELL+20%PU

LINING: MESH

INSOLE: MESH, EVA FOAM

OUTSOLE: RB RUBBER

ADDITIONAL:

WATERPROOF MEMBRANE

REFLECTIVE ELEMENTS



ASH ROSE/MIDNIGHT NAVY

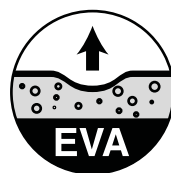

NORUTA WO'S OUTDOOR SHOES

SIZE: 36-41

MATERIAL COMPOSITION:

UPPER: 95%MESH+5%TPU

LINING: MESH

INSOLE: MESH, EVA FOAM

OUTSOLE: EVA PHYLON, RB RUBBER



SKY BLUE/TILE BLUE/LIGHT ORANGE

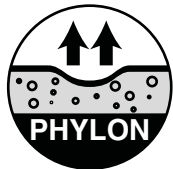
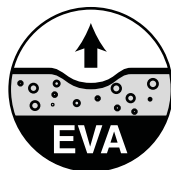

KELES WO'S OUTDOOR SHOES

SIZE: 36-41

MATERIAL COMPOSITION:

UPPER: 95%MESH+5%TPU

LINING: MESH

INSOLE: MESH, EVA FOAM

OUTSOLE: EVA PHYLON, RB RUBBER



BLUE SURF/OIL BLUE

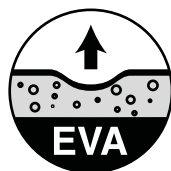

MILKAR WP WO`S OUTDOOR SHOES

SIZE: 36-41

MATERIAL COMPOSITION:

UPPER: MESH

LINING: TEXTILE

INSOLE: : MESH/PU FOAM (ORTHOLITE)

OUTSOLE: EVA PHYLON, RB RUBBER, TPU

SPECIFICATION:

- WATERPROOF MEMBRANE
- GOODYEAR
- ORTHOLITE INSOLE
- REFLECTIVE ELEMENTS



DARK PURPLE / POTENT PURPLE / WATERMELON RED

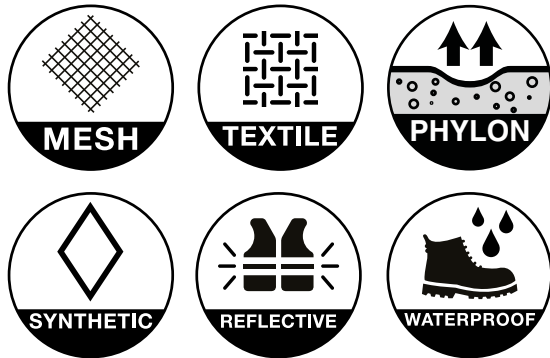

Ortholite®

GOODYEAR

COLUSA WO'S SANDALS

SIZE: 36-41

MATERIAL:

- UPPER: PU, TEXTILE
- LINING: PU
- INSOLE: MD
- OUTSOLE: EVA PHYLON, TPR RUBBER



NAVY/WHITE/WATERMELON RED

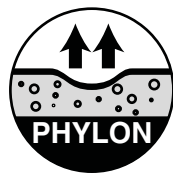

 **LAMIRA WO'S** OUTDOOR SHOES

SIZE: 36-41

MATERIAL COMPOSITION:

NEW PRODUCT



KHAKI/CREAM

LAREN WO`S SANDALS

SIZE: 36-41

MATERIAL COMPOSITION:

- UPPER: PU
- LINING: TEXTILE
- INSOLE: EVA FOAM
- OUTSOLE: RB RUBBER



BLACK /LIGHT BLUE



BLACK/BRIDAL ROSE

LAVERA WO`S SANDALS

SIZE: 36-41

MATERIAL COMPOSITION:

UPPER: PU, WEBBING

LINING: TEXTILE

INSOLE: LEATHER

OUTSOLE: RB RUBBER



SYNTHETIC



LEATHER



RB

WINDSOR WINE / DARK GREY / PINK

LANEVISO WO'S SANDALS

SIZE: 36-41

MATERIAL COMPOSITION:

UPPER: PU, WEBBING

LINING: MESH

INSOLE: TEXTILE

OUTSOLE: EVA PHYLON, TPR RUBBER



SYNTHETIC



MESH



TEXTILE



PHYLON



TPR

NAVY/BLUE/GREEN

FALTIS TEEN OUTDOOR SHOES

SIZE: 36-40

MATERIAL COMPOSITION:

UPPER: 75%MESH+25%PU

LINING: MESH

INSOLE: MESH, EVA FOAM

OUTSOLE: TPR RUBBER

ADDITIONAL:

REFLECTIVE ELEMENTS



TOTAL ECLIPSE/CADIUM YELLOW

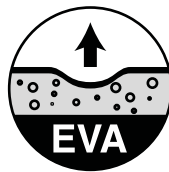

DENOV TEEN OUTDOOR SHOES

SIZE: 36-40

MATERIAL COMPOSITION:

UPPER: MESH + PU

LINING: MESH

INSOLE: MESH, EVA FOAM

OUTSOLE: EVA PHYLON, RB RUBBER

NEW PRODUCT

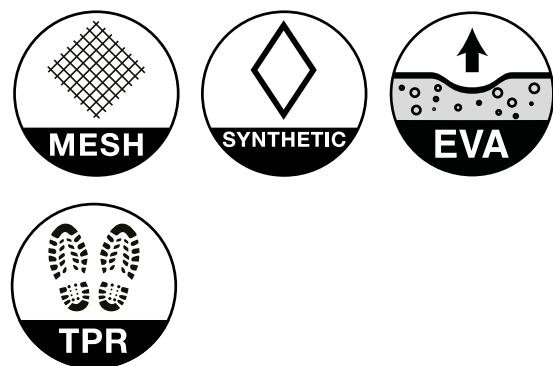

BLACK/DARK GREY

 **ERIMLEY LOW WP JR** OUTDOOR SHOES

SIZE: 28-35

MATERIAL COMPOSITION:

-

SPECIFICATION:

-



ASH ROSE/MIDNIGHT NAVY



DRESS BLUES/DIRECTOIRE BLUE

FALTIS JR OUTDOOR SHOES

SIZE: 28-35

MATERIAL COMPOSITION:
UPPER: 75%MESH+25%PU
LINING: MESH
INSOLE: MESH, EVA FOAM
OUTSOLE: TPR RUBBER

ADDITIONAL:
REFLECTIVE ELEMENTS



PHANTOM/BLACK/SAFFRON

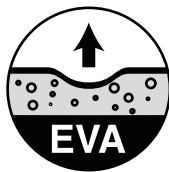

FALTIS JRG OUTDOOR SHOES

SIZE: 28-35

MATERIAL COMPOSITION:
UPPER: 75%MESH+25%PU
LINING: MESH
INSOLE: MESH, EVA FOAM
OUTSOLE: TPR RUBBER

ADDITIONAL:
REFLECTIVE ELEMENTS



PONDEROSA PINE/AZALEA

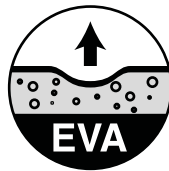

VAPUS WP JR OUTDOOR SHOES

SIZE: 28-35

MATERIAL COMPOSITION:

UPPER: MESH + PU

LINING: MESH

INSOLE: MESH, EVA FOAM

OUTSOLE: EVA PHYLON, TPR RUBBER

SPECIFICATION:

- WATERPROOF

NEW PRODUCT



CITRONELLE/BLACK

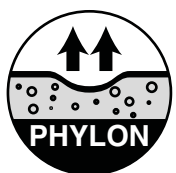
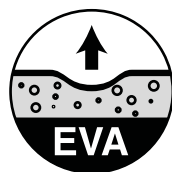

FUCHSIA/BLACK/YELLOW

 **VINDIS JR** OUTDOOR SHOES

SIZE: 28-35

MATERIAL COMPOSITION:

NEW PRODUCT



MINT/FUCHSIA



NAVY/BLUE/LIME

DISCOVERY LACE

SIZE: 75, 90, 120, 150 cm

MATERIAL: POLYESTER FIBRE, TPU



BLACK / WHITE



BLACK / LIME



MINT / YELLOW



NAVY / PINK

BERIN INSOLE

SIZE: 36-37, 38-40, 41-42, 43-44, 45-46

MATERIAL COMPOSITION:
ORTHOLITE FOAM, MESH, EVA

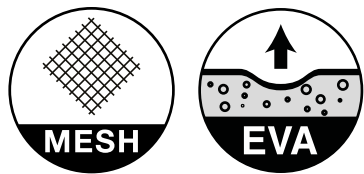

ORANGE / GREY

Ortholite[®]

NOMAD INSOLE

SIZE: 36-37, 38-40, 41-42, 43-44, 45-46

MATERIAL COMPOSITION:
MESH, PU, EVA, TPE

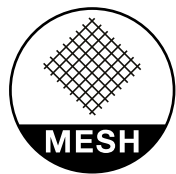

CARIBOU / CITRONELLE

X OLTER INSOLE

SIZE: 36-37, 38-40, 41-42, 43-44, 45-46

MATERIAL COMPOSITION:
ORTHOLITE FOAM, MESH



ORANGE

BAGS, BACKPACK SPRING/SUMMER 2023



DUFFEL BAG 65 BAG

CAPACITY: 65 l

SIZE: 64 x 33 x 33 cm

WEIGHT: 1,1 kg

MATERIAL: TARPAULIN

SPECIFICATION:

- 2 in 1: BACKPACK FUNCTION



BLACK



BRIGHTYBAG 65 BAG

CAPACITY: 65 L

SIZE: 70 x 35 x 35 cm

WEIGHT: 0,9 kg

MATERIAL COMPOSITION:
100% POLYESTER



BLACK

BRIGHTYBAG 45 BAG

CAPACITY: 45 L

SIZE: 30 x 60 x 25 cm

WEIGHT: 0,7 kg

MATERIAL COMPOSITION:
100% POLYESTER

SPECIFICATION:

- ORGANIZER
- WHISTLE
- 2 IN 1



CITRONELLE/BLACK

BRIGHTYBAG 35 BAG

CAPACITY: 35 L

SIZE: 26 x 53 x 25 cm

WEIGHT: 0,6 kg

MATERIAL COMPOSITION:
100% POLYESTER

SPECIFICATION:

- ORGANIZER
- WHISTLE
- 2 IN 1



FLAME SCARLET/BLACK

CARPATIAN 60L TREKKING BACKPACK

CAPACITY: 60 l

SIZE: 77 x 30 x 22 cm

WEIGHT: 1,95 kg

MATERIAL COMPOSITION:

100% POLYESTER

SPECIFICATION:

- CARRYING SYSTEM
- AIR DRAFT SYSTEM
- SHIFT SYSTEM
- RAIN BAG COVER
- H2O SYSTEM
- 2in1 - DETACHABLE CAP
- 3 SIDES OPENING
- YKK BUCKLES



GREEN/FLAME SCARLET



WILDEST 60L TREKKING BACKPACK

CAPACITY: 60 l

SIZE: 75 x 36 x 26 cm

WEIGHT: 1,7 kg

MATERIAL COMPOSITION:
NYLON 300D

SPECIFICATION:

- CARRYING SYSTEM
- VERTICAL FLOW SYSTEM
- ERGONOMIC BACK
- SHIFT SYSTEM
- RAIN BAG COVER
- H2O SYSTEM



DRESS BLUES/TILE BLUE

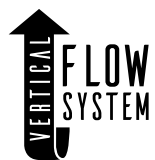

CAMINO 50L TREKKING BACKPACK

CAPACITY: 50 l

SIZE: 70 x 35 x 21 cm

WEIGHT: 1,5 kg

MATERIAL COMPOSITION:

100% POLYESTER

SPECIFICATION:

- CARRYING SYSTEM
- AIR DRAFT SYSTEM
- SHIFT SYSTEM
- RAIN BAG COVER
- H2O SYSTEM
- 1 SIDE OPENING



CHILLI PEPPER/FLAME SCARLET



WILDEST 45L TREKKING BACKPACK

CAPACITY: 45 l

SIZE: 70 x 30 x 22 cm

WEIGHT: 1,4 kg

MATERIAL COMPOSITION:
NYLON 300D

SPECIFICATION:

- CARRYING SYSTEM
- VERTICAL FLOW SYSTEM
- ERGONOMIC BACK
- SHIFT SYSTEM
- RAIN BAG COVER
- H2O SYSTEM



DRESS BLUES/TILE BLUE

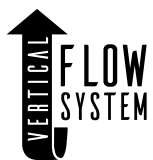

WILDESTA 45 TREKKING BACKPACK

CAPACITY: 45 L

SIZE: 63 x 32 x 25 cm

WEIGHT: 1,4 kg

MATERIAL COMPOSITION:
NYLON

SPECIFICATION:

- ERGONOMIC BACK
- CARRYING SYSTEM
- SHIFT SYSTEM
- VERTICAL FLOW SYSTEM
- RAIN BAG COVER
- H₂O SYSTEM
- RIP STOP

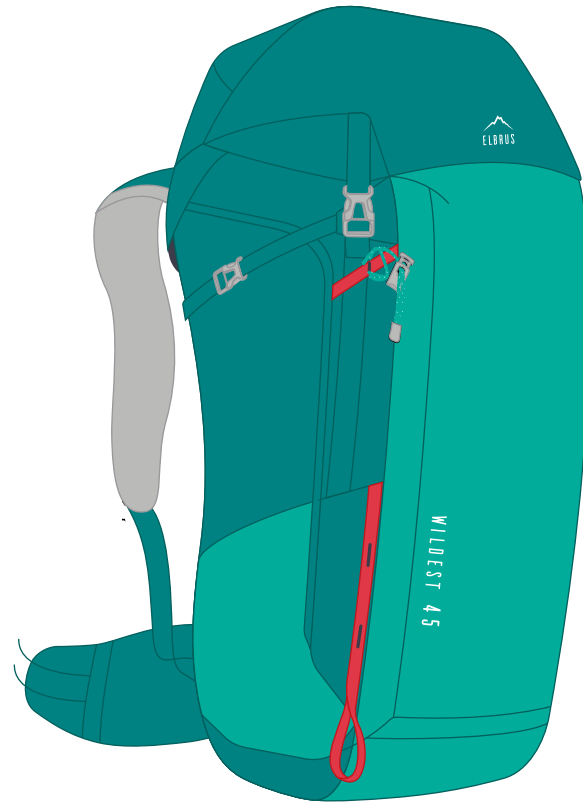

ATLANTIS/LAPIS/HIBISCUS

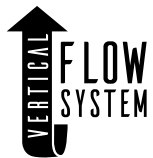

TRIGLAV 40L TREKKING BACKPACK

CAPACITY: 40 l

SIZE: 60 x 34 x 22 cm

WEIGHT: 1,5 kg

MATERIAL COMPOSITION:

100% POLYESTER

SPECIFICATION:

- CARRYING SYSTEM
- AIR DRAFT SYSTEM
- SHIFT SYSTEM
- RAIN BAG COVER
- H2O SYSTEM
- 2 SIDES OPENING



GREEN/FLAME SCARLET

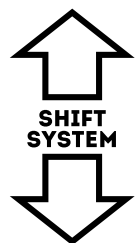

WINDRUNNER 35L TREKKING BACKPACK

CAPACITY: 35 l

SIZE: 64 x 30 x 20 cm

WEIGHT: 1,5 kg

MATERIAL COMPOSITION:

100% POLYESTER

SPECIFICATION:

- CARRYING SYSTEM
- VERTICAL FLOW SYSTEM
- SHIFT SYSTEM
- RAIN BAG COVER
- H2O SYSTEM
- 1 SIDE OPENING



CHILLI PEPPER/FLAME SCARLET

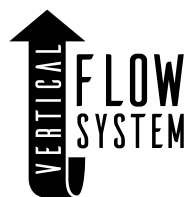

MOONHILL 30 TREKKING BACKPACK

CAPACITY: 30 L

SIZE: 29 x 20 x 54 cm

WEIGHT: 0,9 kg

MATERIAL COMPOSITION:
100% POLYESTER

SPECIFICATION:

- ERGONOMIC BACK
- CARRYING SYSTEM
- VERTICAL FLOW SYSTEM
- RAIN BAG COVER
- H₂O SYSTEM
- WHISTLE
- RIP STOP



FLAME SCARLET/CHILI PEPPER



ERGONOMIC
BACK



CARRYING
SYSTEM



VERTICAL
FLOW
SYSTEM



H₂O
SYSTEM



RIPSTOP



MOONHILL WO'S 30 TREKKING BACKPACK

CAPACITY: 30 L

SIZE: 29 x 20 x 54 cm

WEIGHT: 0,9 kg

MATERIAL COMPOSITION:
100% POLYESTER

SPECIFICATION:

- ERGONOMIC BACK
- CARRYING SYSTEM
- VERTICAL FLOW SYSTEM
- RAIN BAG COVER
- H2O SYSTEM
- WHISTLE
- RIP STOP



NORTH ATLANTIC/BLUE SURF



LYNX 25L TREKKING BACKPACK

CAPACITY: 25 l

SIZE: 50x31x17cm

WEIGHT: 0.7KG

MATERIAL COMPOSITION:
100% POLYESTER

SPECIFICATION:
- CARRYING SYSTEM
- VERTICAL FLOW SYSTEM
- RAIN BAG COVER
- H2O SYSTEM



BLACK/ASPHALT/FLAMESCARLET



AXE 25L TREKKING BACKPACK

CAPACITY: 25 l

SIZE: 52 x 25 x 20 cm

WEIGHT: 0.8 kg

MATERIAL COMPOSITION:
NYLON 300D,

SPECIFICATION:
- CARRYING SYSTEM
- AIR DRAFT SYSTEM
- RAIN BAG COVER
- H2O SYSTEM



FLAME SCARLET/CHILI PEPPER



TILE BLUE/BLUE BIRD

ATLANTIS 22 BACKPACK

CAPACITY: 22 L

SIZE: 48 x 30 x 21 cm

WEIGHT: 0,66 kg

MATERIAL COMPOSITION:
60% POLYESTER, 40% NYLON

SPECIFICATION:

- RAIN BAG COVER
- REFLECTIVE ELEMENTS
- H2O SYSTEM



ASPHALT / FLAME



BLACK PLUM/ELDERBERRY

NEW PRODUCT

DENZEL 30L BACKPACK

CAPACITY: 30 L

SIZE: 53 x 30 x 18 cm

WEIGHT: 0,8 kg

MATERIAL COMPOSITION:
POLYESTER, TPU

SPECIFICATION:

- ERGONOMIC BACK
- WATERPROOF
- ROLL-TOP
- ORGANIZER
- LAPTOP POCKET
- WATERPROOF ZIPPER



DARK FOREST



ERGONOMIC
BACK



WATER
PROOF



ORGANIZER



LAPTOP
POCKET



ORDEN 32L LAPTOP BACKPACK

CAPACITY: 32 l

SIZE: 52 x 32 x 22 cm

WEIGHT: 0.9 kg

MATERIAL COMPOSITION:

POLIESTER, TARPAULIN

SPECIFICATION:

- ERGONOMIC BACK
- CARRYING SYSTEM
- LAPTOP POCKET
- ORGANIZER
- REFLECTIVE
- ANTI SCAN
- USB PORT & POWERBANK WIRE



 **ENVELOP** BACKPACK

CAPACITY:



DARK GREY MELANGE

NEW PRODUCT

CITYMAP 28 BACKPACK

CAPACITY: 25 l

SIZE: 50 x 29 x 20 cm

WEIGHT: 0.7 kg

MATERIAL COMPOSITION:
POLIESTER, TARPAULIN

- SPECIFICATION:
- CARRYING SYSTEM
 - LAPTOP POCKET
 - ORGANIZER
 - REFLECTIVE
 - ANTI RFID



NAVY MELENGE/BLACK

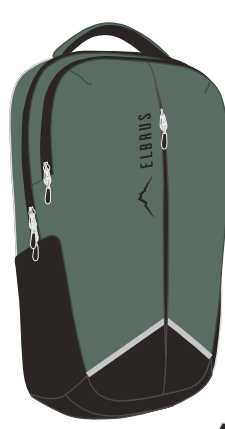

DARK FOREST/BLACK

COTIDIEN URBAN BACKPACK

CAPACITY: 23 L

SIZE: 48x31x16cm

WEIGHT: 0.4KG

MATERIAL COMPOSITION:
100% POLYESTER

SPECIFICATION:
- LAPTOP POCKET
- AUDIO SYSTEM



FLAME SCARLET



BLACK

FOLDIE BACKPACK BACKPACK

CAPACITY:

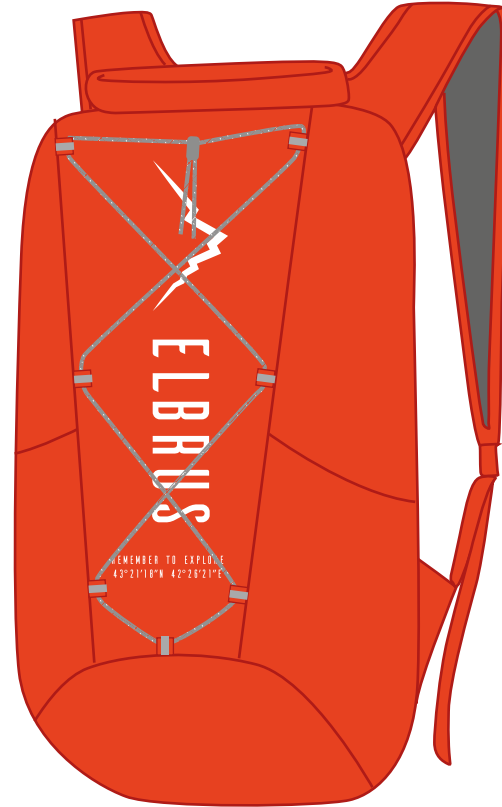

TANGERINE TANGO

NEW PRODUCT



FOLDIES BACKPACK BACKPACK

CAPACITY:



OCEAN DEPTHS / SAFFRON

NEW PRODUCT

QUIVER HIP BAG

CAPACITY: 2 L

SIZE: 31 x 15 x 6 cm

WEIGHT: 0,1 kg

MATERIAL COMPOSITION:
100% POLYESTER



BLACK

SACHET HIP BAG

SIZE: ONE SIZE
WEIGHT: 0,1 kg

MATERIAL COMPOSITION:
100% POLYESTER



MIDNIGHT NAVY/ASH ROSE



URBAN CHICK/BLACK

WALLO WALLET

SIZE: ONE SIZE

MATERIAL COMPOSITION:
100% POLYESTER

SPECIFICATION:
- ORGANIZER



ASH ROSE



BLACK

DRYBAG 30 L WATERPROOF BAG

CAPACITY: 30 l
SIZE: FLAT: 73 x 38 cm; FILLED: 48 x 23 cm
WEIGHT: 0,2 kg

MATERIAL COMPOSITION:
100% POLYESTER

SPECIFICATION:
- WATERPROOF



TANGERINE TANGO

DRYBAG 20 L WATERPROOF BAG

CAPACITY: 20 l
SIZE: FLAT: 73 x 38 cm; FILLED: 48 x 23 cm
WEIGHT: 0,2 kg

MATERIAL COMPOSITION:
100% POLYESTER

SPECIFICATION:
- WATERPROOF



DRYBAG 10 L WATERPROOF BAG

CAPACITY: 10 L

SIZE: FLAT 55 CM x 30 CM; FILLED 37 cm x 20 cm

WEIGHT: 0,1 kg

MATERIAL COMPOSITION:
100% POLYESTER

SPECIFICATION:
- WATERPROOF



SAFFRON



DRY AID WATERPROOF BAG

CAPACITY: 1,5 L

SIZE: FLAT 27 CM X 18 CM; FILLED 17 cm X 11 cm

WEIGHT: 0,1 kg

MATERIAL COMPOSITION:

100% POLYESTER

SPECIFICATION:

- WATERPROOF



RED

DRYBAG LIGHT 35 L WATERPROOF BAG

CAPACITY: 35L

WEIGHT: 95 g

DIMENSIONS: 31 x 69 cm

MATERIAL COMPOSITION: 100% NYLON



CLOISSONE

NEW PRODUCT



DRYBAG LIGHT 25 L WATERPROOF BAG

CAPACITY: 25L

WEIGHT: 80 g

DIMENSIONS: 27 x 60 cm

MATERIAL COMPOSITION: 100% NYLON



TANGERINE TANGO



NEW PRODUCT

DRYBAG LIGHT 15 L WATERPROOF BAG

CAPACITY: 15L

WEIGHT: 70 g

DIMENSIONS: 24 x 53 cm

MATERIAL COMPOSITION: 100% NYLON

NEW PRODUCT



ANTIQUE MOSS



DRYBAG LIGHT 5 L WATERPROOF BAG

CAPACITY: 5L

WEIGHT: 50 g

DIMENSIONS: 17 x 33 cm

MATERIAL COMPOSITION: 100% NYLON

NEW PRODUCT

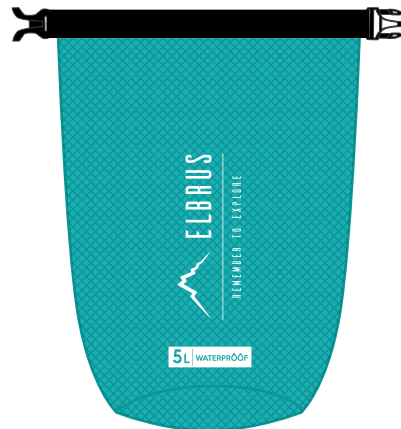

BLUE BIRD



KUSE PILLOW HEADREST

SIZE: ONE SIZE

MATERIAL COMPOSITION:

SHELL: 100% POLYESTER

FILLING: 100% PU

SPECIFICATION:

- MEMORY FOAM

- REMOVABLE COVER



ESTATE BLUE



RED

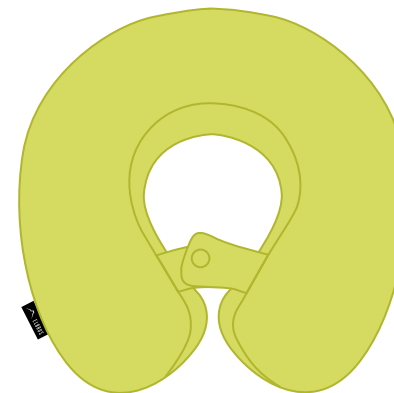

LIME

NOMO TAG TAG

SIZE: ONE SIZE

MATERIAL COMPOSITION:
100% SILICONE

SPECIFICATION:
-

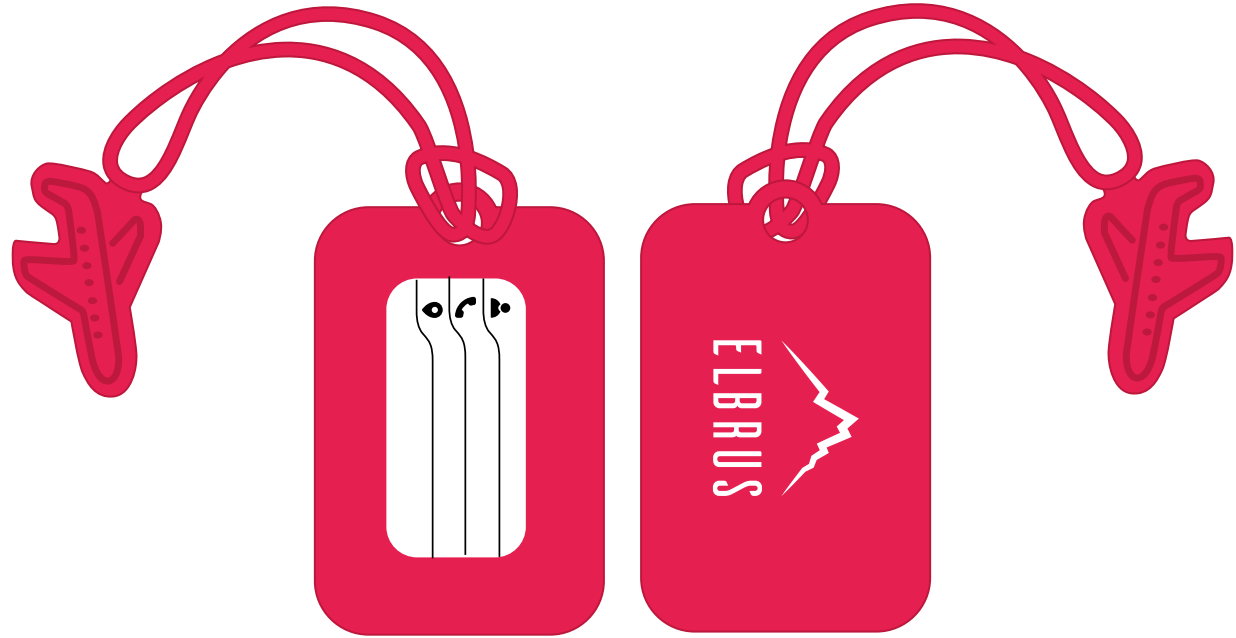

RASPBERRY

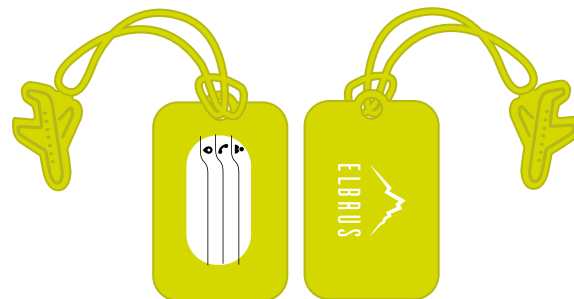

EVENING PROMISE

SILI 89 ML BOTTLE

CAPACITY: 89 ML

MATERIAL COMPOSITION:
SILICONE, PP



BLUE

PINK

EQUIPMENT SPRING/SUMMER 2023



GARDE THERMOS

CAPACITY:

- 1000 ml
- 700 ml
- 500 ml

MATERIAL COMPOSITION:

BODY: STAINLESS STEEL
LID: STAINLESS STEEL, PP
CAP: PP, SILICONE

SPECIFICATION:

- VACUUM INSULATION
- STAINLESS STEEL
- QUICK STOP
- ANTI-LEAK
- BPA FREE

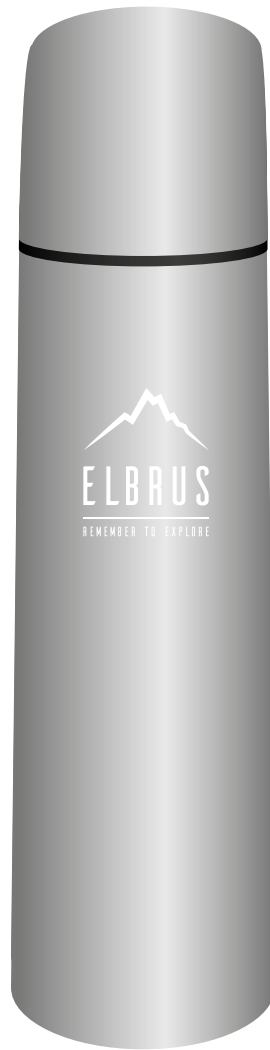

SILVER 1000 ML

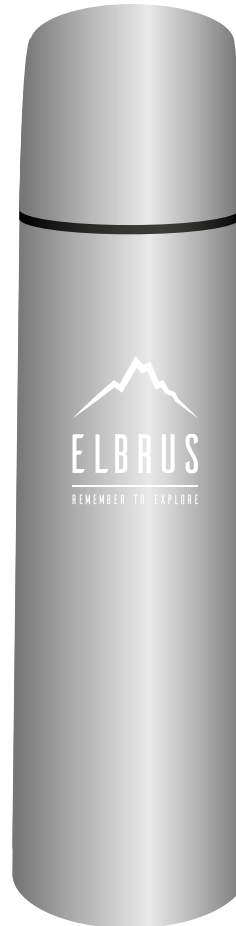

SILVER 700 ML

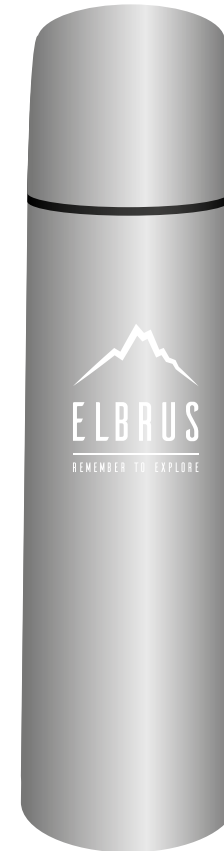

SILVER 500 ML

EGIDE THERMOS

CAPACITY: 500 ML

MATERIAL COMPOSITION:
BODY: STAINLESS STEEL
LID: STAINLESS STEEL, PP
CAP: PP, SILICONE

SPECIFICATION:
- VACUUM INSULATION
- STAINLESS STEEL
- QUICK STOP
- ANTI-LEAK
- BPA FREE



YELLOW GREEN

VACOS WATER BOTTLE

CAPACITY: 730 ML

MATERIAL COMPOSITION:

BOTTLE: STAINLESS STEEL 304

CAP: PP, ABS, SILICONE, STAINLESS STEEL

SPECIFICATION:

- VACUUM INSULATION
- STAINLESS STEEL
- QUICK STOPPER
- ANTI-LEAK
- BPA FREE



SILVER/TEAL

DAKOS THERMAL MUG

CAPACITY: 400 ML

MATERIAL COMPOSITION:

BOTTLE: PP, STAINLESS STEEL

CAP: PP, SILICONE

SPECIFICATION:

- STAINLESS STEEL
- ANTI-LEAK
- BPA FREE



JUNGLE



MAP PRINT

ABRI CUP

CAPACITY: 250 ML

MATERIAL COMPOSITION:
BODY: STAINLESS STEEL 304

SPECIFICATION:
- VACUUM INSULATION
- STAINLESS STEEL
- BPA FREE



YELLOW GREEN



GULP WATER BOTTLE

CAPACITY: 850 ML

MATERIAL COMPOSITION:

BODY: COPOLYESTER

LID: PP, PE, SILICONE, STAINLESS STEEL

SPECIFICATION:

- COPOLYESTER

- ANTI-LEAK

- BPA FREE



LIGHT BLUE/RED

SWIG WATER BOTTLE

CAPACITY: 770 ML

MATERIAL COMPOSITION:

BODY: COPOLYESTER, PP, SILICONE

LID: PP, TPR, COPOLYESTER, SILICONE, STAIN-
LESS STEEL

SPECIFICATION:

- COPOLYESTER
- ANTI-LEAK
- BPA FREE



LIME/TEAL

ANTILA WATERBOTTLE

CAPACITY: 500 ML

MATERIAL COMPOSITION:

BOTTLE: SILICONE

CAP: PP, AS, PCTG, SILICONE, STEEL

HOLDER: ALUMINUM ALLOY

SPECIFICATION:

- TIGHT AND DURABLE
- BPA FREE
- FOLDABLE

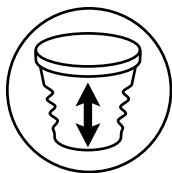

MEDIUM GREY/DARK GREY



RED/DARK GREY

FOLDBOWL BOWL

CAPACITY:

- 1000 ml
- 500 ml

MATERIAL COMPOSITION:

SILICONE

SPECIFICATION:

- BPA FREE
- FOLDABLE

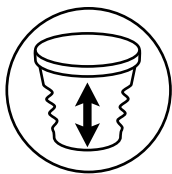

RED 1 L

DARK GREY 0,5 L

FOLDCUP MUG

CAPACITY: 130 ML

MATERIAL COMPOSITION:
SILICONE

SPECIFICATION:
- BPA FREE
- FOLDABLE

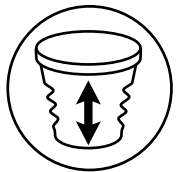

RED

HIKE PRO COOK SET

MATERIAL COMPOSITION:
ALUMINIUM ALLOY
HANDLE: STAINLESS STEEL
HANDLE COVER: SILICONE
WEIGHT: 500 g

1. CAPACITY: 1,2 L
LENGTH: 139 mm
WIDTH: 139 mm
HEIGHT: 106 mm

2. CAPACITY: 0,65 L
LENGTH: 131 mm
WIDTH: 131 mm
HEIGHT: 61 mm

3. CAPACITY: 1 L
LENGTH: 124 mm
WIDTH: 124 mm
HEIGHT: 104 mm

4. CAPACITY: 0,48 L
LENGTH: 115 mm
WIDTH: 115 mm
HEIGHT: 58 mm



GREY/LIME



HIKE KETTLE .

CAPACITY: 0,8 L

WEIGHT: 160 g

MATERIAL COMPOSITION:
ALUMINIUM ALLOY
HANDLE: STAINLESS STEEL
HANDLE COVER: SILICONE



GREY/LIME



CARINA CUTLERY SET (FORK, KNIFE, SPOON)

SIZE: ONE SIZE

MATERIAL COMPOSITION:
PP

SPECIFICATION:
- BPA FREE
- 3in1

NEW PRODUCT



RED



DIRECTORIE BLUE



CITRONELLE



DRESS BLUES



CARRYLIGHT II 1000 MUMMY SLEEPING BAG

SIZE: 220 x 80 cm
PACKED SIZE: 28 x 16 cm

WEIGHT: 1 kg

TEMPERATURE:
COMFORT: + 13°C
LIMIT: + 9°C
EXTREME: - 2°C

MATERIAL COMPOSITION:
SHELL: 100% POLYESTER
LINING: 100% POLYESTER
FILLING: POLYESTER 150 g/m²

SPECIFICATION:
-RIP STOP

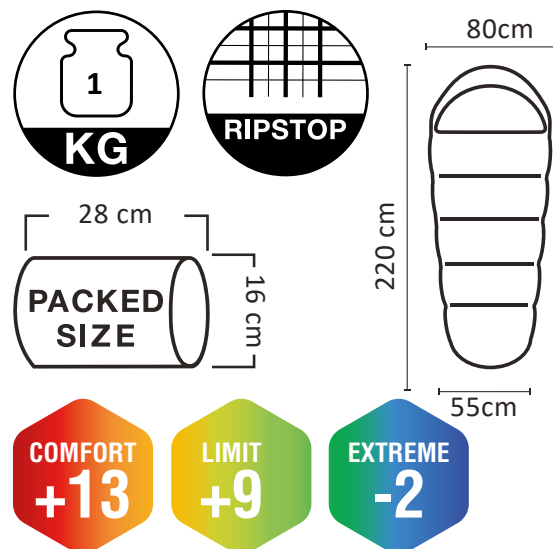

BLACK/FLAME SCARLET

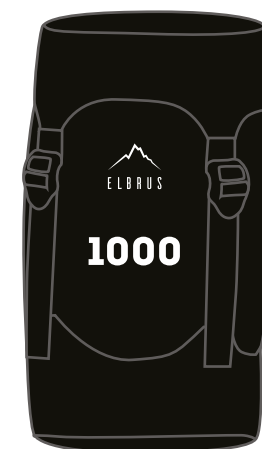

CARRYLIGHT II 800 MUMMY SLEEPING BAG

SIZE: 220 x 80 cm

PACKED SIZE: 27 x 15 cm

WEIGHT: 0,8 kg

TEMPERATURE:

MINIMUM: +16°C

COMFORT: +12°C

MAXIMUM: +2°C

MATERIAL COMPOSITION:

SHELL: 100% POLYESTER

LINING: 100% POLYESTER

FILLING: POLYESTER 110 g/m²

SPECIFICATION:

-RIP STOP

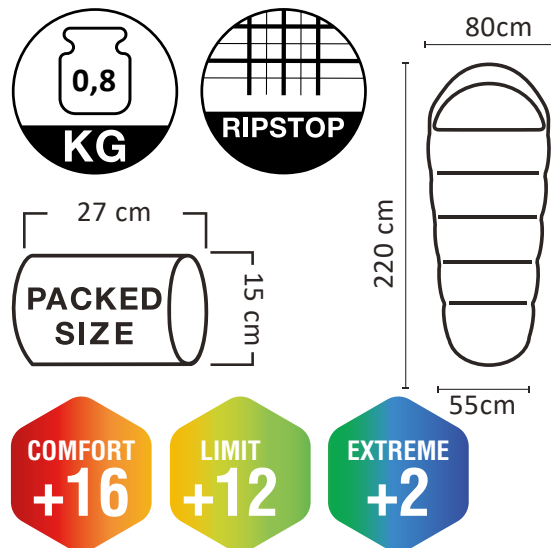

FLAME SCARLE/BLACK



CARRYLIGHT II 600 MUMMY SLEEPING BAG

SIZE: 220 x 80 x 55 cm
PACKED SIZE: 23 x 14 cm

WEIGHT: 0,6 kg

TEMPERATURE:
COMFORT: + 17°C
LIMIT: + 14°C
EXTREME: + 5°C

MATERIAL COMPOSITION:
SHELL: 100% POLYESTER
LINING: 100% POLYESTER
FILLING: POLYESTER 70 g/m²

SPECIFICATION:
-RIP STOP

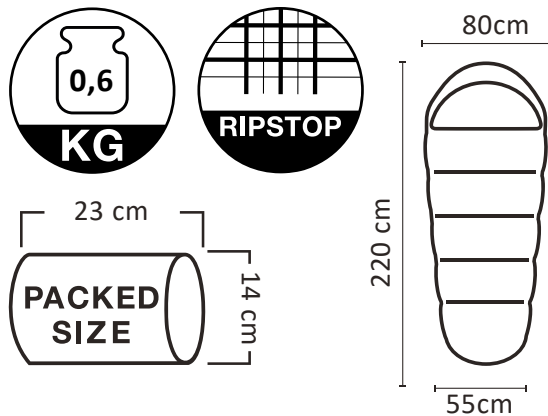

ASPHALT/FLAME SCARLET



ROHITO II MUMMY SLEEPING BAG

SIZE: 220 x 80cm

PACKED SIZE: 38 x 21 cm

WEIGHT: 1,3 kg

TEMPERATURE:

COMFORT: 11°C

LIMIT: 7°C

EXTREME: -5°C

MATERIAL COMPOSITION:

SHELL: 100% POLYESTER 190T

LINING: 100% MICROFIBRE

FILLING: 100% POLYESTER, 250 g/m2

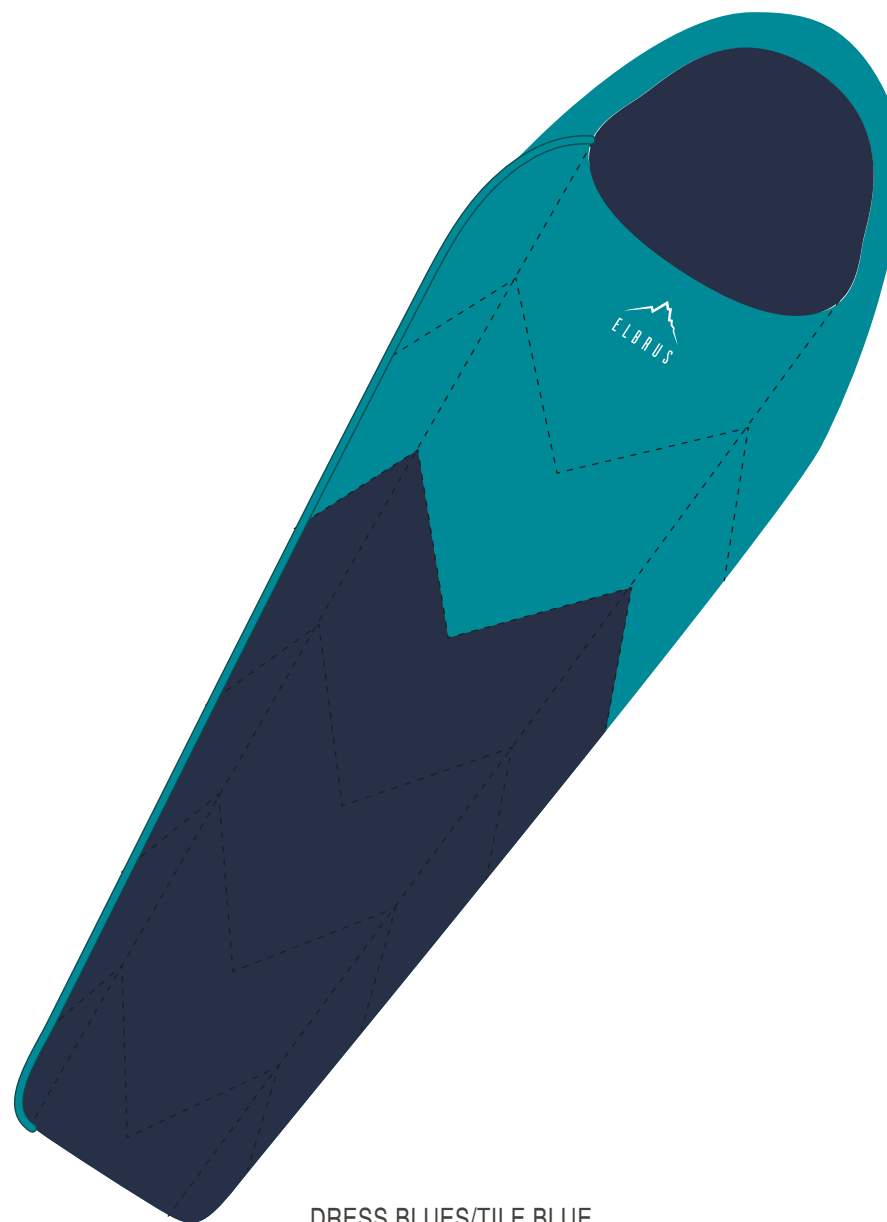
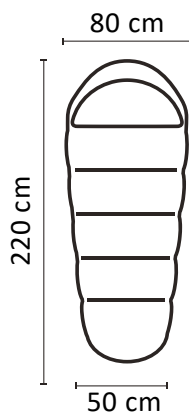
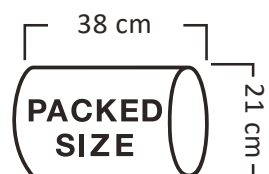

DRESS BLUES/TILE BLUE

NANSEN PRIMALOFT MUMMY SLEEPING BAG



SIZE: 215 x 75 x 50 cm

PACKED SIZE: 15 x 34 cm

WEIGHT: 1 kg

TEMPERATURE:

COMFORT: + 12°C

LIMIT: + 8°C

EXTREME: -4°C

MATERIAL COMPOSITION:

SHELL: 100% POLYESTER

LINING: 100% POLYESTER

FILLING: 100% POLYESTER, PRIMALOFT 100 G/SM

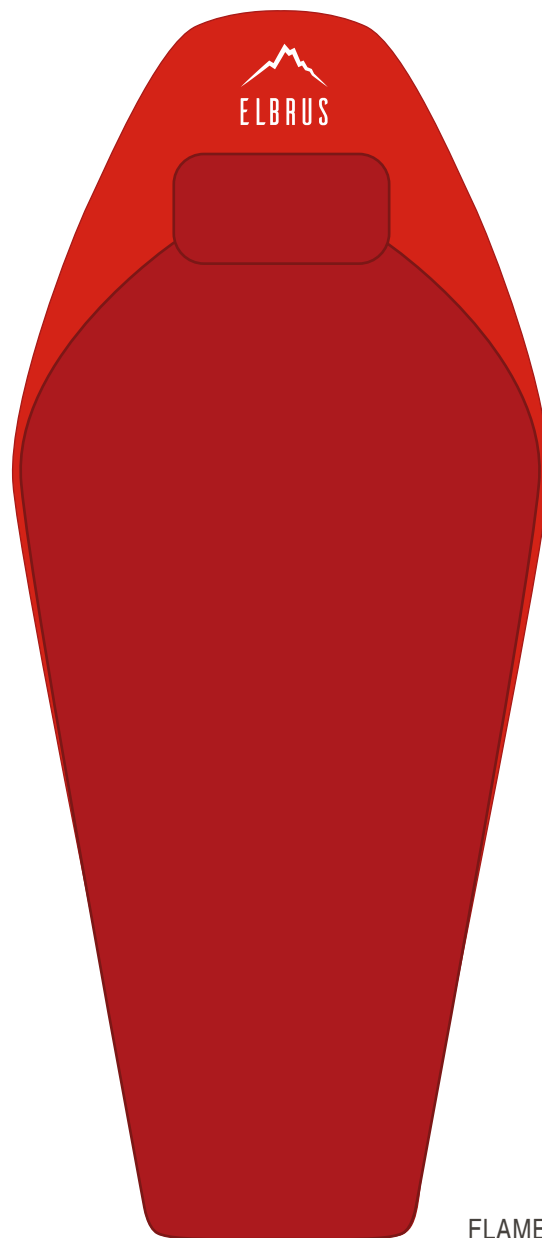
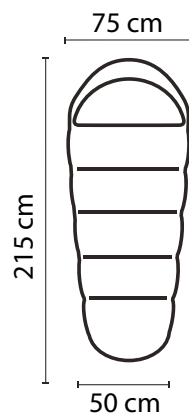
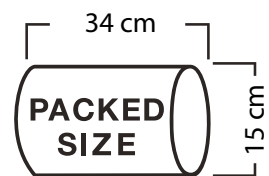

FLAME SCARLET/CHILI PEPPER

KARAKOL PRIMALOFT MUMMY SLEEPING BAG



SIZE: 220 x 80 x 55cm
PACKED SIZE: 21 x 42cm

WEIGHT: 1,5 kg

TEMPERATURE:
COMFORT: + 6°C
LIMIT: + 1°C
EXTREME: -13°C

MATERIAL COMPOSITION:
SHELL: 100% POLYESTER RIPSTOP/POLYESTER 50D
LINING: 100% POLYESTER
FILLING: POLYESTER, PRIMALOFT 200G/SM

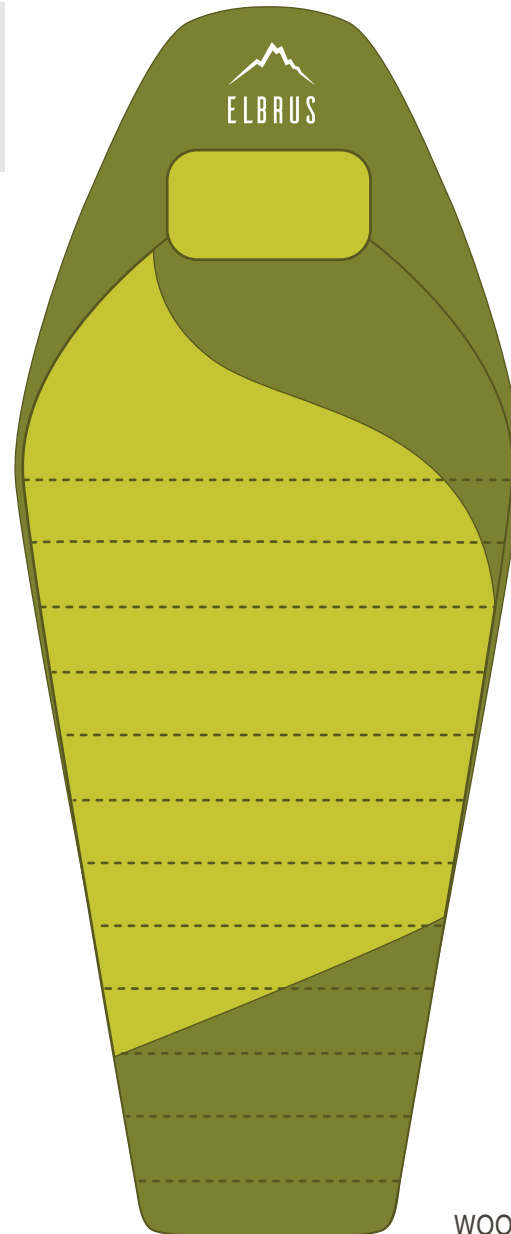
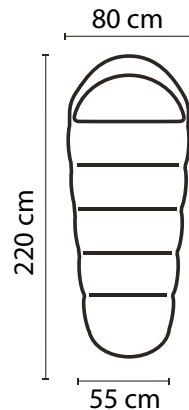
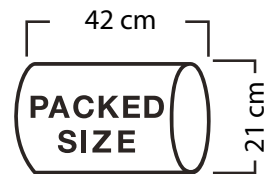

WOODBINE/CITRONELLE

RORAIMA SEAT MAT

DIMENSIONS: 38 x 32 x 1,5 cm

WEIGHT: 50 g,

MATERIAL COMPOSITION:
XPE, ALUMINIUM

NEW PRODUCT



FLAME SCARLET

BLANKET PRO BLANKET

SIZE: 135 x 100 cm

WEIGHT: 400G

MATERIAL COMPOSITION:
100 % Polyester

SPECIFICATION:
- WATERPROOF 8 000 mm H²O
- BREATHABILITY 1 000 g H²O/m²

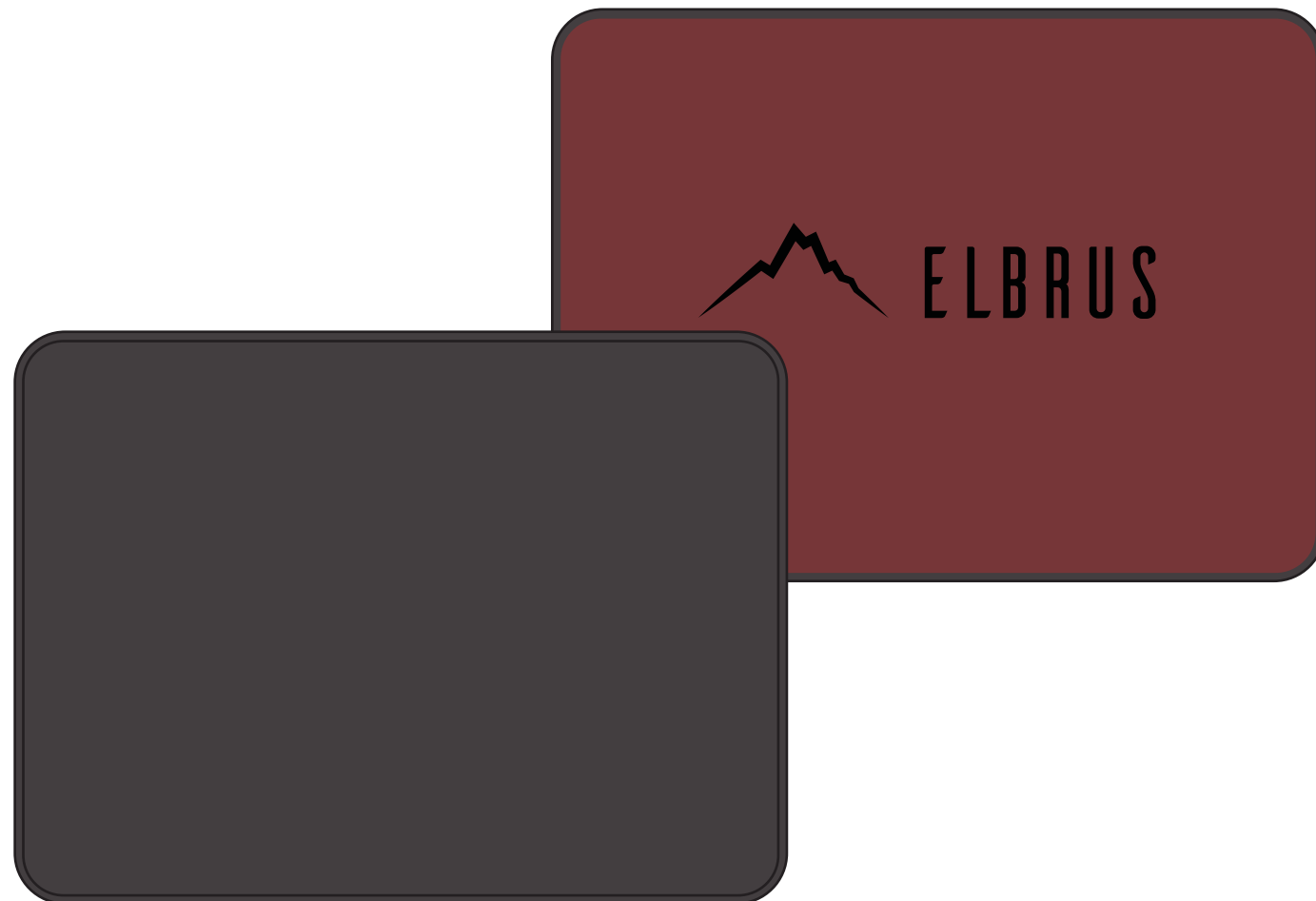

RAVEN/ROSEWOOD

ELMAT SLEEPING PAD

CAMPING MAT

SIZE: 180 x 50 x 0,7 cm

WEIGHT: 200G

MATERIAL COMPOSITION:
XPE, PE, ALUMINIUM



ORANGE/GREY

ARIES AIR MATTRESS

INFLATABLE SLEEPING PAD

SIZE: 190 x 70 x 6 cm

DIAMETER: 13cm

MATERIAL COMPOSITION:
100% NYLON

NEW PRODUCT



FLAME SCARLET

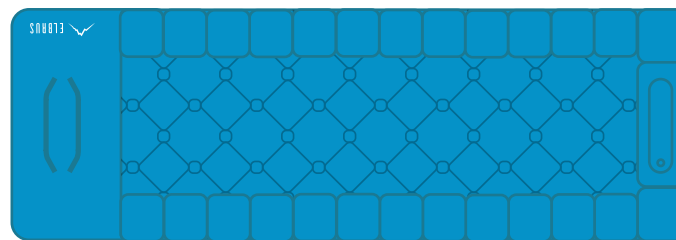

BLUE

POKARA TREKKING POLES

SSIZE: 62-135 cm

WEIGHT (SINGLE POLE): 200 g

MATERIAL COMPOSITION:

STICK: ALUMINIUM 7075

HANDLE: EVA FOAM, PP

TIP PROTECTORS: TPR

TIPS: TUNGSTEN CARBIDE

SPECYFICATION:

- 3 SECTIONS
- INCHECK LOCK
- DURABLE RUBBER TIPS
- WIDIA
- ADJUSTABLE STRAPS

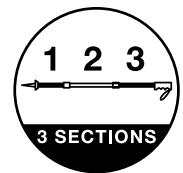

BLUE/ORANGE

KATMANDU TREKKING POLES

SIZE: 62-135 cm

WEIGHT (SINGLE POLE): 240 g

MATERIAL COMPOSITION:

STICK: ALUMINIUM 7075

HANDLE: EVA FOAM, PP

TIP PROTECTORS: TPR

TIPS: TUNGSTEN CARBIDE

SPECIFICATION:

- 3 SECTIONS
- OUTCHECK LOCK
- DURABLE RUBBER TIPS
- WIDIA
- ADJUSTABLE STRAPS

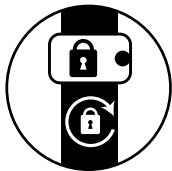
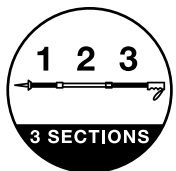

RED/BLACK

CLIOGO NORDIC WALKING POLES

SIZE: 85-135 cm

WEIGHT: 240 g

MATERIAL:

STICK: ALUMINIUM

HANDLE: PP, TPR

GLOVE: NEOPRENE

TIP PROTECTORS: TPR

TIPS: CARBON STEEL

SPECIFICATION:

- 3 SECTIONS
- OUTCHECK LOCK
- DURABLE RUBBER TIPS
- WIDIA
- GLOVE CLICK
- ADJUSTABLE STRAPS

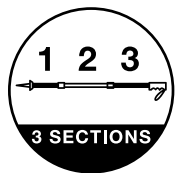

RED

GREEN

NEW PRODUCT

BLASIMON NORDIC WALKING POLES

SIZE: 85-135 cm

WEIGHT: 160 g (SINGLE POLE)

MATERIAL:

STICK: 50% CARBON

HANDLE: PP, EVA

GLOVE: PP

TIP PROTECTORS: TPR

TIPS: TUNGSTEN

SPECIFICATION:

- 2 SECTIONS

- OUTCHECK LOCK

- DURABLE RUBBER TIPS

- ADJUSTABLE STRAPS

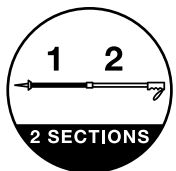

CERAMIC/LIME PUNCH

SFERIS TENT

SIZE: 210 x 135+60 x 100 cm
PACKED SIZE: 55 x 15 cm

WEIGHT: 2,4 kg

MATERIAL COMPOSITION:

- RAIN FLY: 100% POLYESTER
- INNER: 100 % POLYESTER
- FRAME: ALUMINIUM
- FLOOR: POLYESTER

SPECIFICATION:

- WATERPROOF RAIN FLY: 3000 mm
- WATERPROOF FLOOR: 3000 mm
- TAPED SEAMS
- ALUMINIUM FRAME
- 2 PERSON CAPACITY



JUNE BUG/ORANGE



GAMACHER GAITERS

SIZE:

M: 22,5 CM x 40CM

L: 24 CM x 41CM

MATERIAL COMPOSITION:

SHELL FABRIC: 100% NYLON

TAPE: TPU



BLACK

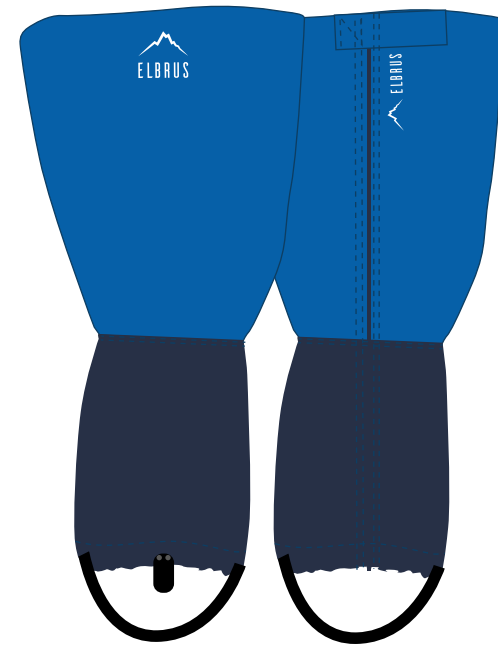

DIRECTORIE BLUE/DRESS BLUES

ALPIDO MAT

SIZE: 140 x 200 cm

PACKED SIZE: 12 x 16 cm

WEIGHT: 230 g

MATERIAL COMPOSITION:

100% POLYESTER

SPECIFICATION:

- 4 X PEGST



FLAME SCARLET/BLACK

JODALIGHT HEADLAMP

MATERIAL COMPOSITION:

BODY: ABS

TAPE: POLYESTER

WEIGHT: 85 g

SPECIFICATION:

- LEDS: WHITE (LED CREE XP-G3), RED

- 260 LUMENS

- WATERPROOF IPX4

- BATTERY: 1200 mAh LI-ION POLYMER (BATTERY INCLUDED)

- USB RECHARGEABLE

- 3 LIGHT FUNCTION (WHITE LED: MEDIUM INTENSE 30%, INTENSE 100%, PULSE)

- ON/OFF SENSOR

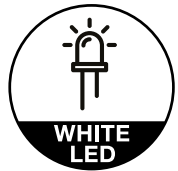
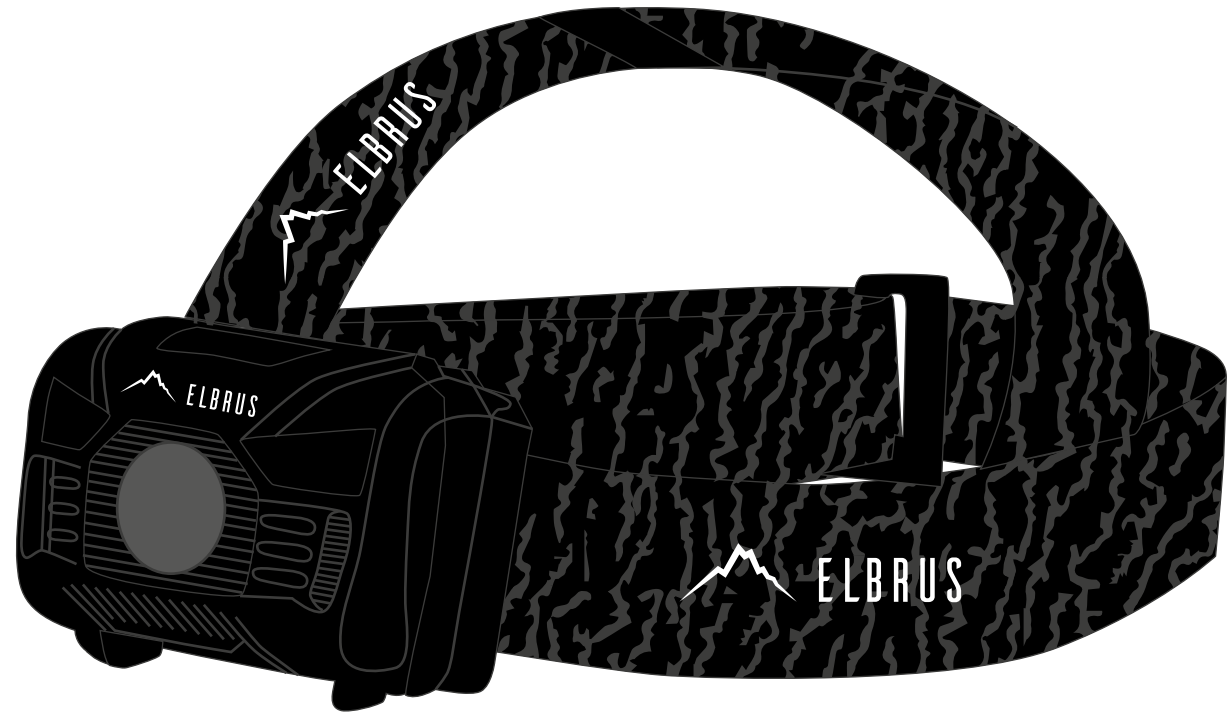

WHITE
LED



260
LUMENS



WATER
PROOF



INCLUDED



RECHARGEABLE



3 LIGHT
FUNCTION

BLACK/ASPHALT

RUIZA SUNGLASSES

SIZE: ADULT

MATERIAL COMPOSITION:

FRAME: GRILAMID TR90, RUBBER

LENS: 1,0 mm TAC

SPECIFICATIONS:

- UV400
- 3 UV FILTER
- POLARIZATION
- REVO
- TR90 FRAME



FLAME SCARLET / BLACK

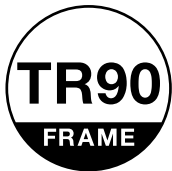
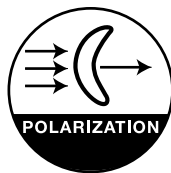
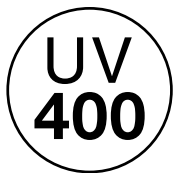

NEW PRODUCT

NEVIS SUNGLASSES

SIZE: ADULT

MATERIAL COMPOSITION:

FRAME : TR90

LENS : 1.0mm TAC

SPECIFICATIONS:

-UV400

-3 UV FILTER

-POLARIZATION

-TR90 FRAME

NEW PRODUCT



ANTIQUE MOSS

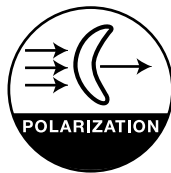

BLACK/ORCHID MIST

LYON SUNGLASSES

SIZE: ADULT

MATERIAL COMPOSITION:

FRAME: GRILAMID TR90, RUBBER

LENS: 1,0 mm TAC

SPECIFICATIONS:

- UV400
- 3 UV FILTER
- POLARIZATION
- REVO
- TR90 FRAME



DRESS BLUES / DIRECTORIE BLUE

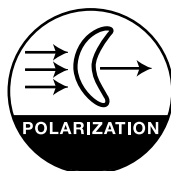

NEW PRODUCT

 **WASH & CARE 315 ML** IMPREGNAT



 **WASH & PROTECT 315 ML** IMPREGNAT



X **DOWN WASH 315 ML** IMPREGNAT

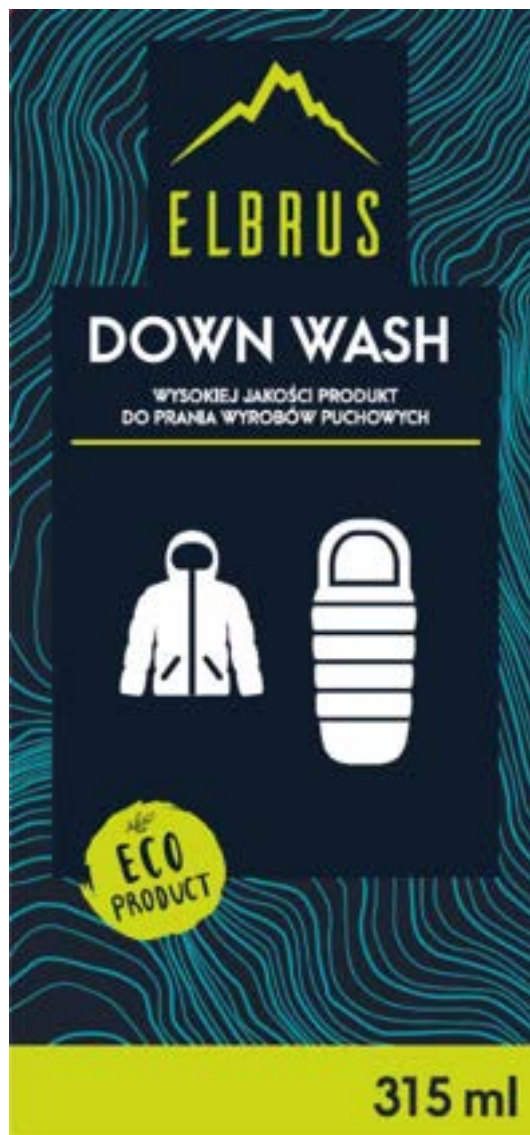

 **WASH & CARE 20 G** IMPREGNAT

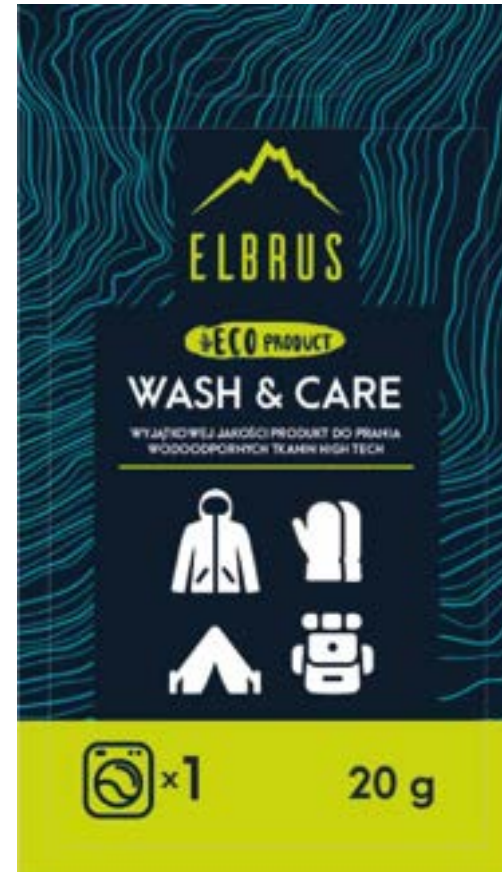

WASH & PROTECT 20 G IMPREGNAT



X DOWN WASH 20 G IMPREGNAT

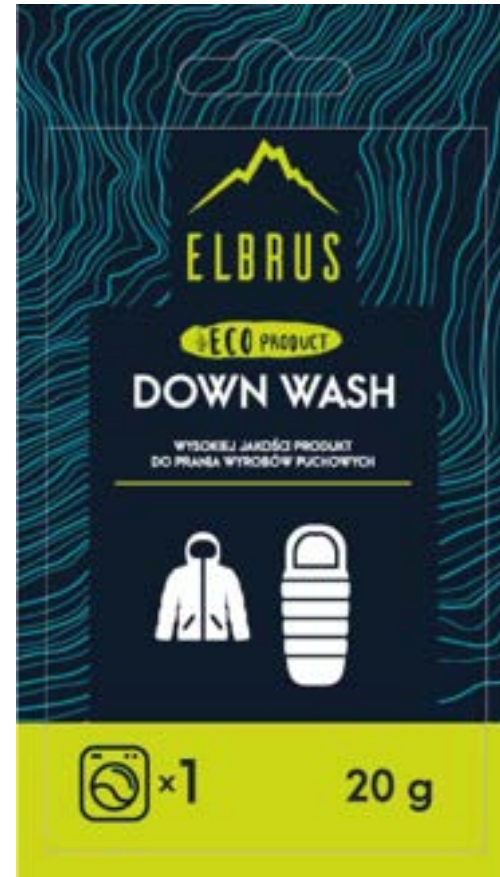

POLAR WASH 20 G IMPREGNAT

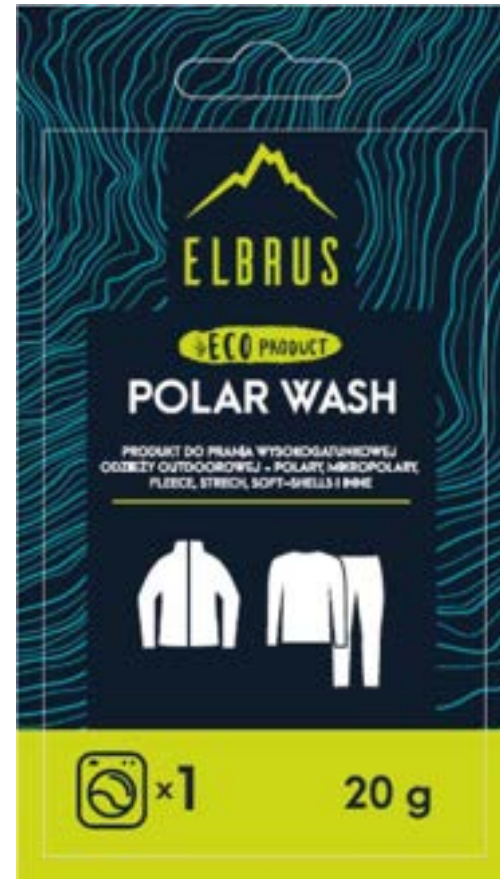

X SILVER REFRESHER 20 G IMPREGNAT



ECO PROTECTOR 200 ML IMPREGNAT



ECO SHOE CLEAN 200 ML IMPREGNAT



✕ ECO GREASE 100 ML IMPREGNAT



ECO SHOE DEO 200 ML IMPREGNAT



